

EXPERT PANEL REPORT

---

# Structural Performance of Christchurch CBD Buildings in the 22 February 2011 Aftershock

---

Covering:

Canterbury Television Building

Pyne Gould Corporation Building

Hotel Grand Chancellor Building

Forsyth Barr Building

February 2012

Report of an Expert Panel  
appointed by the New Zealand Department of Building and Housing

---

This report supersedes the Stage 1 Expert Panel Report dated 30 September 2011, and reflects the subsequent thinking of the Panel taking into account the CTV Building investigation findings.

EXPERT PANEL REPORT

---

# **Structural Performance of Christchurch CBD Buildings in the 22 February 2011 Aftershock**

---

## TABLE OF CONTENTS

<b>1.0</b>	<b>Introduction</b>	<b>4</b>
<b>2.0</b>	<b>Objectives, Scope and Terms of Reference</b>	<b>6</b>
2.1	Objectives	6
2.2	Scope	6
2.3	Terms of Reference	8
<b>3.0</b>	<b>Approach</b>	<b>10</b>
3.1	Expert Panel	10
3.2	Consultant appointments/scope of activities	13
3.3	Department management and support	13
3.4	Information from other parties	13
3.5	Review of report material by selected parties	14
3.6	Contact with Canterbury Earthquakes Royal Commission of Inquiry	14
3.7	Consultant reports	14
3.8	Site and materials investigations	14
<b>4.0</b>	<b>Context</b>	<b>15</b>
4.1	Earthquake events	15
4.2	Impacts of 22 February 2011 aftershock	16
4.3	Ground shaking and building response	19
<b>5.0</b>	<b>Canterbury Television Building</b>	<b>26</b>
5.1	Overview	26
5.2	Investigation	28
5.3	Building description	28
5.4	Structural modifications	29
5.5	Earthquake and other effects prior to 22 February 2011	30
5.6	Collapse on 22 February 2011	30
5.7	Eye-witness accounts	31
5.8	Examination of collapsed building	31
5.9	Collapse evaluation	32
5.10	Key data and results	41
5.11	Possible collapse scenario	47
5.12	Compliance/standards issues	50
5.13	Conclusions	52
5.14	Recommendations	53
<b>6.0</b>	<b>Pyne Gould Corporation Building</b>	<b>54</b>
6.1	Summary	54
6.2	Investigation	54
6.3	Building description	56
6.4	Structural modifications	58
6.5	Design basis and code compliance	58
6.6	Geotechnical	58
6.7	Seismological	58
6.8	Effects of 4 September 2010 earthquake and 26 December 2010 aftershock	59
6.9	Effects of 22 February 2011 event	59
6.10	Probable reasons for collapse	59
6.11	Conclusions	59
6.12	Recommendations	62

<b>7.0</b>	<b>Hotel Grand Chancellor Building</b>	<b>63</b>
7.1	Summary	63
7.2	Investigation	63
7.3	Building description	64
7.4	Structural modifications	66
7.5	Design basis and code compliance	66
7.6	Geotechnical	66
7.7	Seismological	66
7.8	Effects of 4 September 2010 earthquake and 26 December 2010 aftershock	67
7.9	Effects of 22 February 2011 event	67
7.10	Probable reasons for structural failure	69
7.11	Conclusions	70
7.12	Recommendations	70
<b>8.0</b>	<b>Forsyth Barr Building</b>	<b>72</b>
8.1	Summary	72
8.2	Investigation	72
8.3	Building description	73
8.4	Structural modifications	76
8.5	Design basis and code compliance	76
8.6	Geotechnical	76
8.7	Seismological	76
8.8	Effects of 4 September 2010 earthquake and 26 December 2010 aftershock	77
8.9	Effects of 22 February 2011 event	77
8.10	Mode of collapse	78
8.11	Probable reasons for stair failure	80
8.12	Conclusions	80
8.13	Recommendations	81
<b>9.0</b>	<b>Principal findings and recommendations</b>	<b>82</b>
9.1	Introduction	82
9.2	Building investigations	83
9.3	Findings and recommendations	85
9.4	Summary of recommendations	96
<b>LIST OF REPORT APPENDICES</b>		<b>99</b>
<b>Appendix A</b>	<b>Panel members' biographies</b>	<b>100</b>
<b>Appendix B</b>	<b>Information obtained</b>	<b>103</b>
<b>Appendix C</b>	<b>Glossary of terms</b>	<b>107</b>
<b>Appendix D</b>	<b>CTV Building consultant report</b>	<b>112</b>
<b>Appendix E</b>	<b>PGC Building consultant report</b>	<b>120</b>
<b>Appendix F</b>	<b>Hotel Grand Chancellor Building consultant report</b>	<b>123</b>
<b>Appendix G</b>	<b>Forsyth Barr Building consultant report</b>	<b>126</b>
<b>Appendix H</b>	<b>Contextual report</b>	<b>130</b>

## 1.0

## Introduction

The Magnitude 7.1 Darfield earthquake on 4 September 2010 caused extensive damage to buildings and infrastructure in the Canterbury region including areas of Christchurch city and suburbs. Although damage was significant and widespread, there were no major building collapses and no loss of life. The Magnitude 4.9 aftershock on 26 December 2010 caused further damage. The impact from both events on modern buildings was low.

On 22 February 2011 a Magnitude 6.3 aftershock centred near Lyttelton caused severe damage to Christchurch, particularly the Central Business District (CBD), eastern and southern suburbs, the Port Hills, and Lyttelton. Ground shaking intensities in Christchurch city, both horizontal and vertical, were in excess of those used as a basis for building design at any time up to the present day. As a result of the aftershock on 22 February 2011, 182 people died and many more were seriously injured. Many masonry buildings or parts of these buildings collapsed in the CBD and many modern building structures were critically damaged. At least two multi-storey buildings collapsed and stairs collapsed in several modern multi-storey buildings.

The New Zealand Government, through its Department of Building and Housing, responded to public concern about damage to major buildings and identified for investigation four large multi-storey buildings in the Christchurch CBD which failed during the 22 February 2011 aftershock. The buildings included in the investigation are the Canterbury Television Building (CTV), the Pyne Gould Corporation Building (PGC), the Hotel Grand Chancellor Building and the Forsyth Barr Building. Two of these buildings experienced collapse and the other two experienced significant failure of building components, including stairs, columns and walls. Damage to these buildings is representative of many of the structural engineering effects that the earthquake and aftershocks have caused to commercial buildings in Christchurch.

A Stage 1 Expert Panel report was released on 30 September 2011 and covered the PGC, Hotel Grand Chancellor and Forsyth Barr buildings for which investigations had been completed. Further analyses were found to be necessary for the CTV Building in order to develop a full understanding of its behaviour in the 22 February 2011 aftershock, and the role of identified vulnerabilities in the collapse.

This report details the findings of the investigations on the four buildings, including the reasons for the building failures, key technical issues found and recommendations to the Department and the Government in relation to changes needed in codes, standards, design and/or construction practices necessary to achieve adequate levels of building safety in major earthquakes in New Zealand.

The results of the investigations conducted on these buildings assisted the Panel in making recommendations on future design and construction issues related to buildings in areas prone to seismic activity.

Chapter 2 in this report outlines the objectives, scope and Terms of Reference for these investigations, while Chapter 3 describes the approach taken. Chapter 4 provides a contextual section outlining the general effects of the 22 February 2011 aftershock and the preceding 2010 earthquake and aftershock events.

Summaries of the investigations into the CTV, PGC, Hotel Grand Chancellor and Forsyth Barr buildings are provided in chapters 5, 6, 7 and 8 of this report. The more detailed consultant reports on each building are contained in appendices as separate volumes to this report.

## 1.0 INTRODUCTION

Cover pages and tables of contents for the consultant reports are contained in appendices D, E, F and G to this report. In the case of the Forsyth Barr Building consultant's report, there are addenda containing material additional to the version of that report that was released with the Stage 1 Expert Panel Report on 30 September 2011.

Chapter 9 presents the key findings of the investigations, highlights the important technical issues resulting from the investigations and gives recommendations aimed at improving future design and construction practices.

## 2.0

# Objectives, Scope and Terms of Reference

## 2.1 Objectives

The objectives of the investigation were as follows:

- To determine the facts about the performance of four critical buildings in the Christchurch CBD during the 22 February 2011 aftershock, establishing the causes of, and factors contributing to, the building failures. This includes consideration of the effects of the 4 September 2010 earthquake and 26 December 2010 aftershock.
- To provide a comprehensive analysis of these causes and contributing factors, including, as context, the building standards and construction practices when these buildings were constructed or alterations were made to them.

## 2.2 Scope

The buildings identified to be investigated were:

- Canterbury Television Building at 249 Madras Street
- Pyne Gould Corporation Building at 233 Cambridge Terrace
- Hotel Grand Chancellor Building at 161 Cashel Street
- Forsyth Barr Building at 764 Colombo Street.

The investigation has focused on the structural performance of each building and on any relevant factors which contributed to or may have contributed to the collapse of the building or other structural failures.

The investigation has reviewed and reported on:

- the original design and construction of the buildings, including the foundations and soils investigations
- the impact of any alterations and/or maintenance on the structural performance of the buildings
- estimation of the probable ground shaking at the buildings' sites
- any structural assessments and reports made on the buildings, including those made during the emergency period following the 4 September 2010 earthquake
- the structural performance of the buildings in the 4 September 2010 earthquake and the 26 December 2010 aftershock, and in particular the impact on components that failed in the 22 February 2011 aftershock
- any further structural assessments and reports on the stability/safety of the buildings following the 4 September 2010 earthquake or the 26 December 2010 aftershock
- the cause(s) of the collapse or failure of the buildings.



## 2.0 OBJECTIVES, SCOPE AND TERMS OF REFERENCE

The investigation has also considered:

- the design codes, construction methods and building controls in force at the time the buildings were designed and constructed and changes over time as they applied to these buildings
- knowledge of the seismic hazard and ground conditions when these buildings were designed
- changes over time to knowledge in these areas
- any policies or requirements of any agency to upgrade the structural performance of the buildings.

### “Codes” and “Standards” – clarification

There may be some confusion with references made to the Building Code, the Code, codes, standards and/or Standards. All of these terms refer to elements of the building controls regime as it affects the design and construction of buildings. The current system under the Building Act 2004 is as follows:

- Building Code (or the Code), using capital letters, refers to the New Zealand Building Code. This is a high-level performance-based document that defines the overall objectives, functional requirements and performance requirements for buildings. The Building Code covers safety, health, well-being and sustainability. Structural requirements are contained in Clause B1 of the Building Code.
- Compliance Documents related to Clause B1 of the Building Code refer to certain New Zealand Standards. Compliance with the Standards (note capital ‘S’) cited in the Compliance Document for Building Code Clause B1 is deemed to be compliance with the relevant provisions of the performance requirements of the Building Code.
- Compliance with the Building Code thus implies compliance with relevant Standards, such as those for earthquake actions, concrete structural design and so on. This is often loosely referred to as compliance with the code or with standards.

This building controls regime has been in place in New Zealand since 1991. Before that date, more prescriptive requirements were defined in legislation and New Zealand Standard Specifications.

In general terms, in this report, reference to compliance with the code means that the structural design (or construction) was in accordance with the relevant requirements of the building controls regime at the time.

Each investigation used available records of building design and construction, and invited and obtained evidence in the form of photographs, video recordings and first-hand accounts of the state or performance of the buildings prior to, during and after the 22 February 2011 aftershock.

## 2.3 Terms of Reference

The Terms of Reference for the Department's investigation are shown in the table on the following page.

The investigation timelines as detailed in the Terms of Reference were extended. This was necessary to allow for delays in gaining access to sites to complete the necessary forensic investigations; to identify and interview eye-witnesses; to examine the effects of the 4 September 2010 earthquake, 26 December 2010 aftershock and 22 February 2011 aftershock; to analyse a range of potential failure mechanisms; and to allow for comments by selected parties.

### Matters outside the scope of the investigation

The investigations and reports have established, where possible, the likely cause or causes of building failures. They did not, and were not intended to, address issues of culpability or liability. These matters were outside the scope of the investigation. To be consistent with this and to focus on the issues raised in the investigation, the Panel decided not to use the names of the parties professionally associated with the buildings. This has been applied throughout the investigation documents.

## 2.0 OBJECTIVES, SCOPE AND TERMS OF REFERENCE

### Terms of Reference for the Department's investigation

#### Technical Investigation into the Performance of Buildings in the Christchurch CBD in the 22 February 2011 Christchurch Aftershock

##### Terms of Reference

The Canterbury region suffered a severe earthquake on 4 September 2010 and an aftershock on Boxing Day. This was followed by another, more damaging aftershock on 22 February 2011. The Magnitude 6.3 aftershock on 22 February 2011 caused significant damage to Christchurch, particularly the CBD, eastern, and southern suburbs, the Port Hills, and Lyttelton.

The high intensity of ground shaking led to a number of collapsed or seriously damaged buildings and a large number of people killed or seriously injured. It is important for New Zealanders that the reasons for the damage to buildings generally in the CBD, and to some particular buildings, are definitively established.

##### Matters for investigation

The buildings specified for detailed analysis include the: Pyne Gould Corporation; CTV; Forsyth Barr and Hotel Grand Chancellor buildings. Others may be specified for detailed analysis as information comes to hand during the investigation.

The purpose of this technical investigation into the performance of buildings in the Christchurch CBD during the 22 February aftershock, is to establish and report on:

- the original design and construction of the buildings;
- the impact of any alterations to the buildings;
- how the buildings performed in the 4 September 2010 earthquake, and the Boxing Day aftershock, in particular the impact on the buildings;
- what assessments, including the issuing of green stickers and any further structural assessments, were made about the buildings' stability/safety following the 4 September 2010 earthquake, and the Boxing Day aftershock; and
- why these buildings collapsed or suffered serious damage.

The investigation will take into consideration:

- the design codes, construction methods, and building controls in force at the time the buildings were designed and constructed and changes over time as they applied to these buildings;
- knowledge that a competent structural/geotechnical engineer could reasonably be expected to have of the seismic hazard and ground conditions when these buildings were designed;
- changes over time to knowledge in these areas; and
- any policies or requirements of any agency to upgrade the structural performance of the buildings.

The investigation will use records of building design and construction, and will also obtain and invite evidence in the form of photographs, video recordings and first-hand accounts of the state or the performance, of the buildings prior to, during, and after the 22 February 2011 aftershock.

##### Matters outside the scope of the investigation

The investigation and report is to establish, where possible, the cause or causes of building failures. It is not intended to address issues of culpability or liability arising from the collapse of the building. These matters are outside the scope of the investigation.

##### Report required

The Department will prepare a detailed written report, setting out the conclusions drawn from this investigation about the matters referred to in the above section by 31 July 2011.

## 3.0

## Approach

### 3.1 Expert Panel

Following a request from Government, the Department initiated the investigations by appointing professional engineering consultants for each building and a professional engineer to carry out initial forensic testing on three of the four buildings. To oversee this work, the Department established a Panel of Experts; and the Terms of Reference for the Expert Panel (Panel) are set out on the following page. The Department managed the work of the consultants and the Panel and provided additional resources to support the project including engineering, secretarial, legal and communications personnel.

The Panel who have produced this report were appointed to provide guidance on the methodology of the investigations, to review and approve the consultants' reports and to report on their implications. Panel members were chosen to provide a background of experience in the range of matters related to the planning, design, approval and construction of buildings.

This report is based on the findings and conclusions of the consultants engaged by the Department of Building and Housing. It was not the function of the Panel to undertake a full engineering peer review of those findings and conclusions.

Members of the Panel and authors of this report are:

- Sherwyn Williams (Chair), Consultant, Kensington Swan, Auckland, construction law expert.
- Professor Nigel Priestley (Deputy Chair), Emeritus Professor of Structural Engineering at the University of California, San Diego, specialist and leading authority on earthquake design of structures.
- Dr Helen Anderson, Consultant, former Chief Executive of the Ministry of Research, Science and Technology, specialist knowledge in seismology.
- Marshall Cook, Architect, past Adjunct Professor of Design at Unitec, Auckland, specialist knowledge of building design for earthquakes.
- Peter Fehl, Director Property Services, University of Auckland, Auckland, specialist knowledge of construction and construction industry practice.
- Dr Clark Hyland, Hyland Consultants, Auckland, specialist forensic and earthquake engineer.
- Rob Jury, Technical Director-Structural Engineering, Beca, Wellington, specialist structural design engineer.
- Peter Millar, Tonkin and Taylor, Auckland, specialist knowledge of geotechnical engineering practice.
- Professor Stefano Pampanin, Associate Professor at the College of Engineering, University of Canterbury, Christchurch, specialist and leading authority on earthquake design of structures.
- George Skimming, Director Special Projects at Wellington City Council, Wellington, specialist knowledge of territorial authority roles in building procurement.
- Adam Thornton, Director, Dunning Thornton, Wellington, specialist structural design engineer.

## 3.0 APPROACH

Brief biographies of Panel members are given in Appendix A.

Particular roles and responsibilities of the Panel were as follows:

- Providing guidance and direction to the investigation.
- Advising on the scope and extent of investigation necessary to achieve the overall objectives of the investigation.
- Monitoring and reviewing the approaches, investigations, data and outputs of the consultants.
- Recommending to the Department any changes in the scope and nature of work necessary to address the matters for investigation fully, accurately and authoritatively.
- Reviewing and approving the consultants' reports on each building.
- Producing an overview report addressing the matters for investigation and indicating any issues for further consideration by the Department in its role as the regulator responsible for the Building Act and Building Code.

### Terms of Reference for the Expert Panel

#### Technical Investigation into the Performance of Buildings in the Christchurch CBD in the 22 February Christchurch Aftershock

##### General

Overall Terms of Reference for the investigation are given [on page 8].

Investigations will look at the expected performance of the buildings, when they were built, the impact of any alterations, compliance with the code at the time, and the reasons for the collapse. The investigations will focus only on the technical findings and are not to address liability.

The Department of Building and Housing has overall responsibility for the outcome of the investigation and has appointed:

- Engineering consultants to investigate the subject buildings
- A panel of experts to assist in achieving the overall objectives of the investigation

These Terms of Reference for Expert Panel describe the roles and responsibilities of the expert panel in the context of the overall Terms of Reference for the investigation.

##### Outline Approach and Outputs

The main outputs of the investigation will be:

- Consultant technical investigation reports on each building
- A report prepared by the Expert Panel to the Department
- A Department report to the Minister on the outcome of the investigation.

The investigating consultants will be responsible for their own work and for determining the inputs they use to reach their conclusions. The consultant reports will be attachments to the Expert Panel Report.

The Department Report will be based on material in the consultant reports and the Expert Panel Report.

## 3.0 APPROACH

### Terms of Reference for the Expert Panel – continued

#### **Roles and Responsibilities**

The panel members have been chosen to provide a background of experience in the range of matters related to the planning, design, approval and construction of buildings.

In general, it is expected that, individually and collectively, panel members will help the Department to provide comprehensive, accurate and authoritative accounts of why the buildings collapsed and what the implications are for the Building Act and Code.

Particular roles and responsibilities include:

- Providing guidance and direction to the investigation.
- Advising on the scope and extent of investigation necessary to achieve overall objectives.
- Monitoring and reviewing the approaches, investigations, data and outputs of the engineering consultants.
- Recommending to the Department any changes in the scope and nature of work necessary to address the matters for investigation fully, accurately and authoritatively.
- Reviewing and approving the engineering consultant reports on each building.
- Producing an overview report addressing the matters for investigation and indicating any issues for further consideration by the Department in their role as regulator responsible for the Building Act and Code.

#### **Timeframe**

The Department Report to the Minister is due by 31 July 2011. The Expert Panel Report is due by 30 June 2011. These deadlines may be revised if necessary for the investigation to achieve its objectives.

#### **Conflicts of Interest**

##### **General**

Panel members must declare all conflicts or potential conflicts of interest throughout the investigation. A register will be maintained which will be accessible to all members.

##### **Interaction with engineering consultants**

Panel members may provide comments to consultants in their role as panel members, but may not provide advice. Panel members are to advise other panel members of all such comments given as soon as possible.

Tonkin & Taylor may provide advice to consultants provided that Peter Millar is not personally involved.

## 3.0 APPROACH

### 3.2 Consultant appointments/scope of activities

The Department engaged New Zealand professional engineering consultants to carry out detailed investigations and structural analyses of each building.

The companies appointed were:

- CTV Building: Hyland Consultants/StructureSmith (Dr Clark Hyland, Ashley Smith)
- PGC Building: Beca (Rob Jury, Dr Richard Sharpe)
- Hotel Grand Chancellor Building: Dunning Thornton (Adam Thornton, Alistair Cattanach)
- Forsyth Barr Building: Beca (Rob Jury, Dr Richard Sharpe).

Dr Clark Hyland, Rob Jury, and Adam Thornton were Panel members. Ashley Smith, Dr Richard Sharpe and Alistair Cattanach attended Panel meetings on occasion to present and discuss the investigations and their findings.

Panel members, individually and collectively, and through the work of the consultants, have helped to provide comprehensive and authoritative accounts of why the buildings collapsed or failed and what the implications are for the Building Act and Building Code.

### 3.3 Department management and support

Work of the Panel and the consultants was supported by Departmental representatives led by:

- David Kelly, Deputy Chief Executive, Building Quality
- Mike Stannard, Chief Engineer
- Dr David Hopkins, Senior Technical Advisor.

Dr David Hopkins, a specialist consultant in structural and earthquake engineering, managed the activities of the Panel and the consultants on behalf of the Department. He helped shape the technical scope and content of the Panel and consultant reports and contributed to the technical discussions of the Panel.

The Department provided management, secretarial and editorial support, in addition to facilitating access to information to assist the Panel and the consultants. Vicky Newton was the Project Co-ordinator and Pam Johnston the Technical Writer for the Panel report.

### 3.4 Information from other parties

The Department invited evidence from members of the public and organisations involved or affected who could supply photographs, video recordings and first-hand accounts of the state or performance of each building prior to, during, and after the 22 February 2011 aftershock.

A total of 34 people contacted the Department to provide evidence. All offers of evidence were passed on to the consultants who made further contact with those people where it was relevant to their investigations.

A number of people were identified to be interviewed. Interviews were conducted with building owners, people who worked on the buildings while being constructed, tenants of the buildings at the time of the earthquake and aftershock events, and eye-witnesses who saw or experienced the collapse or failure of the buildings. Some interviews were conducted with the assistance of an experienced investigative interviewer resource from the Ministry of Social Development, and most were recorded and transcribed for ease of reference.

## 3.0 APPROACH

### 3.5 Review of report material by selected parties

The Panel gave considerable thought to allowing selected parties the opportunity to comment on the relevant consultant reports before public release. Those considered for referral included the owners, designers and builders, and the Christchurch City Council.

Without in any way addressing any questions of liability or culpability, it was decided to refer the relevant consultant reports to selected parties.

The parties to whom the reports were referred were asked to advise the Department of Building and Housing if they had any information that would cause the Panel to alter the consultants' final reports. Comments received were considered in producing their final reports and this Panel report.

### 3.6 Contact with Canterbury Earthquakes Royal Commission of Inquiry

The Royal Commission was known to have a strong interest in the results of these investigations and common objectives in finding reasons and recommending changes. Contact was maintained with the Royal Commission and information of mutual interest was shared at key stages.

### 3.7 Consultant reports

The consultants gathered available information for their analyses of the buildings including:

- approved building consent drawings
- Christchurch City Council property files
- drawings, calculations and structural specifications supplied by the designers of the original buildings and any subsequent alterations
- how the buildings performed in the 4 September 2010 earthquake, in particular the impact of the earthquake on the buildings
- what assessments (including the issuing of green stickers and any further structural assessments) were made about the buildings' stability/safety following the 4 September 2010 earthquake
- media, police and USAR team photos
- interviews with building owners, those involved in the construction and design of the original buildings and subsequent alterations, tenants of the buildings and eye-witnesses to the collapse or failure of the buildings
- public evidence including accounts of the state of the buildings prior to the earthquake, opinions of those who had worked on or in the buildings and photos showing the state of the buildings prior to and after the earthquake and aftershocks.

### 3.8 Site and materials investigations

Investigations have included:

- site examinations to make initial observations on the nature of the failures
- retrieval of material samples for testing
- laboratory testing of the samples taken.



## 4.0

## Context

## 4.1 Earthquake events

The Magnitude 6.3 Lyttelton earthquake event of 22 February 2011 at 12.51pm was an aftershock of the Magnitude 7.1 Darfield (Canterbury) earthquake which occurred on Saturday 4 September 2010 at 4.35am. The Darfield event resulted in extensive areas of liquefaction, land damage and widespread damage to buildings and infrastructure in the Canterbury region. The earthquake epicentre was approximately 35km west of the Christchurch central business district (CBD). Figure 4.1 shows the fault rupture associated with the 4 September 2010 earthquake (red line) and epicentre (green star, arrowed). Other faults marked as dotted yellow lines are inferred from locations of aftershocks. Green circles show the locations of aftershocks that occurred before 22 February 2011. The size of the circle is indicative of the magnitude of the aftershock.

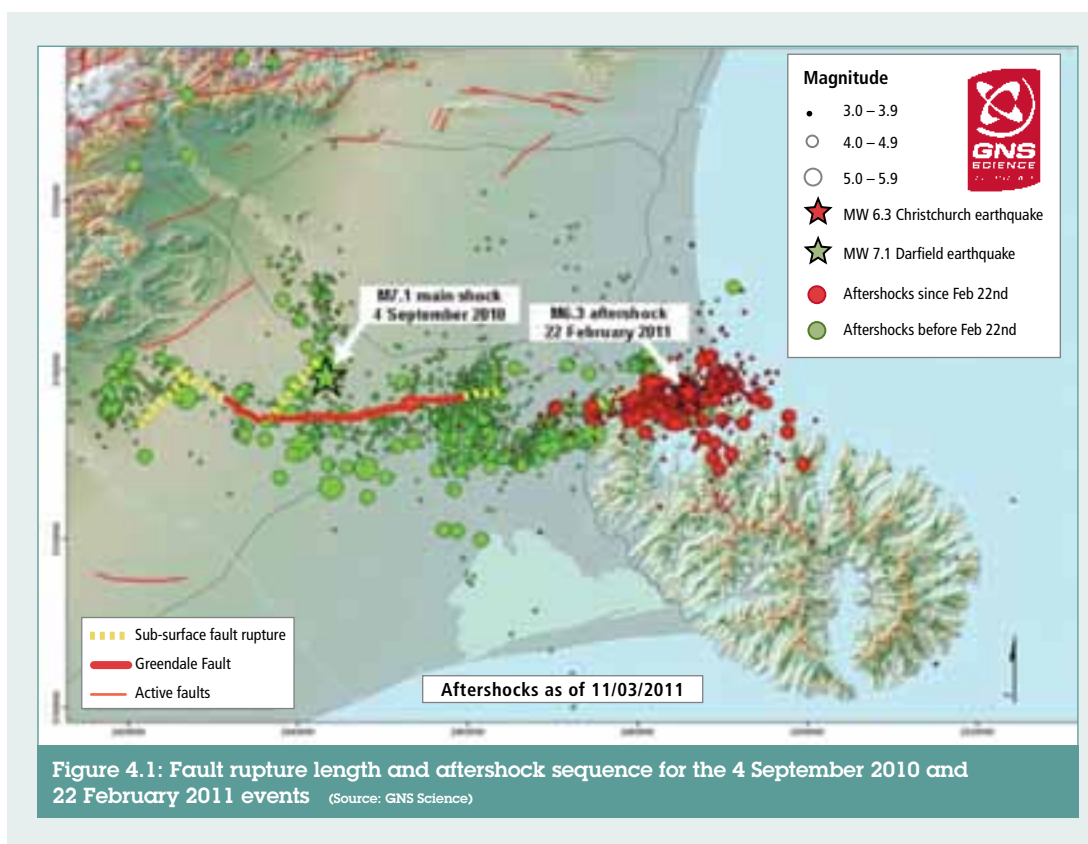

## 4.0 CONTEXT

While the impact of the Darfield earthquake was widespread and severe, there were no major modern building collapses and no loss of life. There was substantial damage to unreinforced masonry buildings (URM), largely in the CBD, but the time of the earthquake meant that few people were exposed to the hazard of falling masonry, which represented the bulk of building damage.

Several thousand aftershocks, including several Magnitude 5.0+ aftershocks, followed in the months after the 4 September 2010 earthquake, including the Magnitude 4.9 aftershock on 26 December 2010 that caused further damage in the CBD. The latter event was very close to the CBD and produced significant ground shaking in Christchurch City despite the significantly lower magnitude.

The Magnitude 6.3 Lyttelton aftershock occurred at 12.51pm on Tuesday 22 February 2011, approximately five months after the Magnitude 7.1 Darfield (Canterbury) earthquake. The epicentre of the 22 February 2011 event was approximately 10km south-east of the CBD, near Lyttelton, at a depth of approximately 5km. This is shown as a red star (arrowed) on Figure 4.1. The red circles show the locations and indicate the magnitude of the aftershocks between 22 February 2011 and 11 March 2011.

## 4.2 Impacts of 22 February 2011 aftershock

Due to the proximity of the epicentre of the 22 February 2011 aftershock to the CBD, its shallow depth and distinctive directionality effects, very strong shaking was experienced in the city centre, the eastern suburbs, and the Lyttelton-Sumner-Port Hills areas. The shaking intensity of the 22 February 2011 aftershock recorded in the City of Christchurch was much greater than that of the main shock on 4 September 2010. The recorded values of peak vertical accelerations, in the range of 1.8 and 2.2 times gravity (1.8g and 2.2g) near the epicentre, were amongst the highest ever recorded in an urban environment. However, while these accelerations were very high, the relatively short duration of the events moderated their effects. In the CBD the highest values of peak ground vertical accelerations recorded were between 0.5g and 0.8g.

This event resulted in 182 fatalities, extensive damage and collapse of numerous URM buildings, damage to many multi-storey buildings in the CBD, collapse of two multi-storey buildings and widespread liquefaction affecting residential and commercial properties as shown in Figure 4.4. Most tall buildings in Christchurch are within the CBD, indicated by the green circle.

Figure 4.2 and Figure 4.3 show a comparison of peak ground accelerations (both horizontal and vertical) recorded by the GeoNet Network in the CBD area for the 4 September 2010 and 22 February 2011 events.

On each map, the red vertical arrows represent the peak vertical accelerations and the blue horizontal arrows represent the peak horizontal accelerations. The acceleration scales are the same for both maps. The horizontal scale shows the peak acceleration regardless of its direction.

For the 22 February 2011 event, a wide range of (medium to very high) horizontal ground accelerations was recorded, with peaks exceeding 1.6g near the epicentre and between 0.4g and 0.7g in the CBD stations. This variation confirms strong dependence on the distance from the epicentre, and also reflects the variability of soil characteristics.

There are two points of particular note in the context of this investigation:

- The values of recorded accelerations for the 22 February 2011 event in the CBD are markedly greater than the comparable values on 4 September 2010.
- The values for the 22 February 2011 event reduce markedly and rapidly when moving to the west of the CBD.

## 4.0 CONTEXT

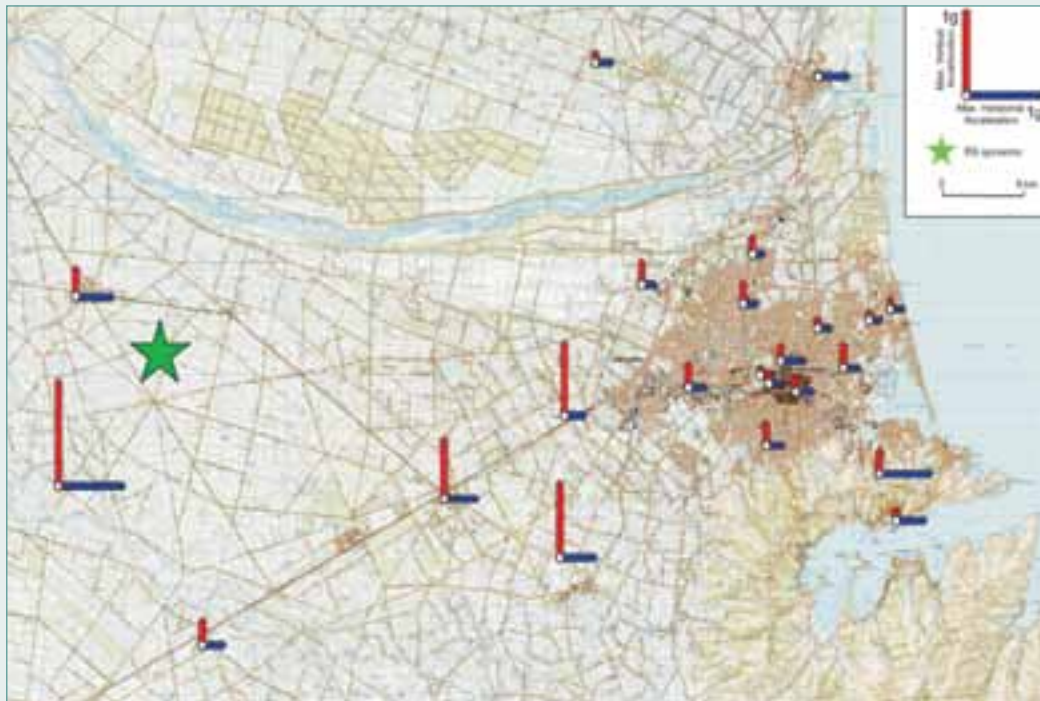

Figure 4.2: Recorded peak ground accelerations – 4 September 2010 (Source: EQC-GNS Science (GeoNet))

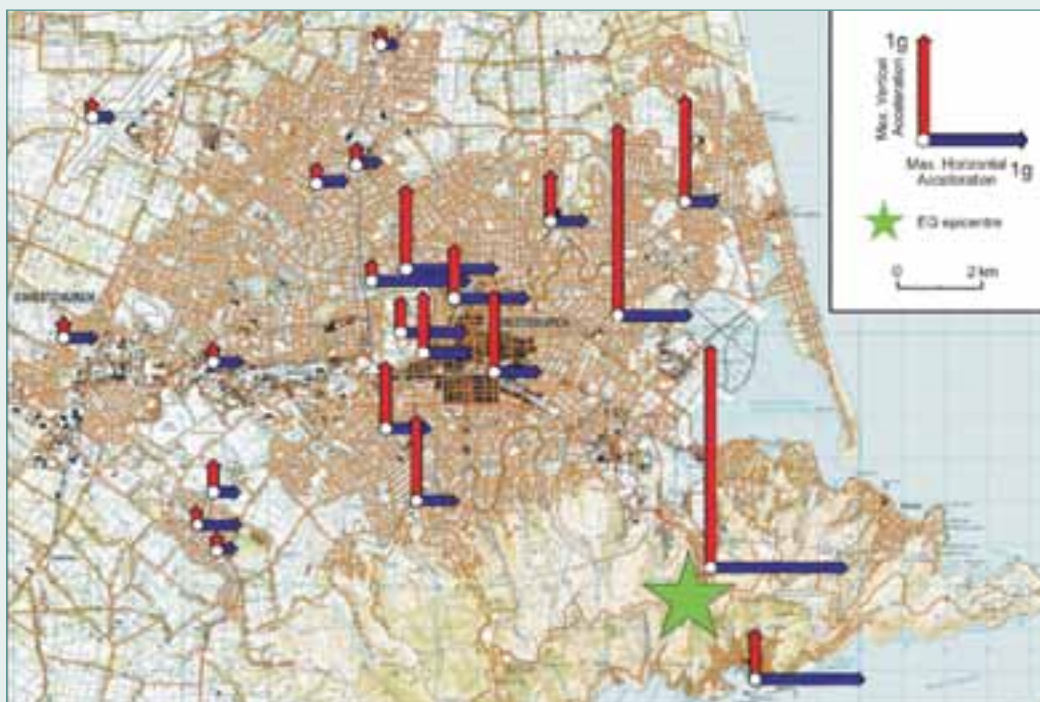

Figure 4.3: Recorded peak ground accelerations – 22 February 2011 (Source: EQC-GNS Science (GeoNet))

## 4.0 CONTEXT

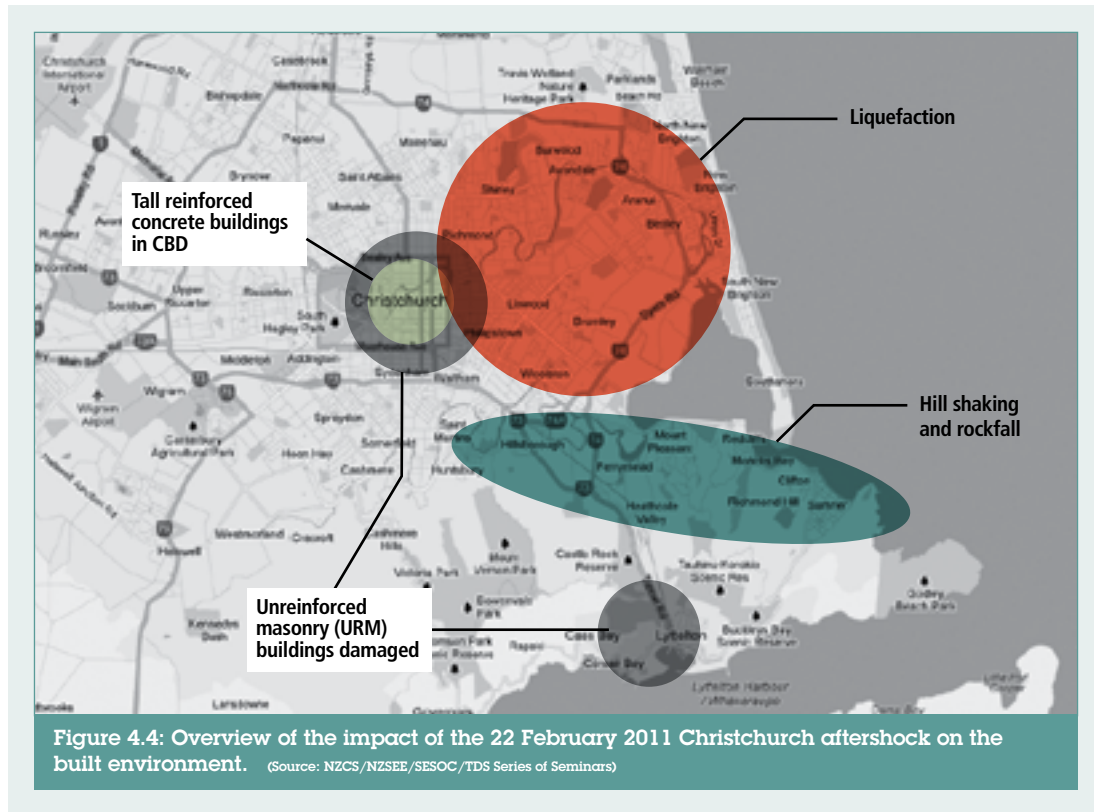

Figure 4.5 is an aerial view of the CBD showing the locations of the four buildings investigated.



## 4.0 CONTEXT

## 4.3 Ground shaking and building response

### 4.3.1 General

Earthquake-resistant structural design over the past 50 years has sought to prevent the collapse of structures under strong earthquake shaking while recognising that damage, even irreparable structural damage, could occur in such conditions. Over recent years designers have sought to produce greater resilience in key structural members, especially columns and walls, and to control damage to the building fabric generally. Typically, buildings are designed for earthquake ground shaking intensities expected to occur, on average, not more than once every 500 years. Modern design standards are such that design (and construction) to this level is intended to provide a significant margin of safety against collapse when subject to the design shaking. Many buildings would be expected to survive significantly stronger shaking without collapse.

However, damage to buildings, even those designed and built to the most recent standards, can be expected. In “design-level” shaking, this damage may be beyond repair and thus require the demolition of the building. The underlying design philosophy is to focus on life safety and to accept, or at least tolerate, the possible need to replace the building after such a low probability event.

### 4.3.2 Response of buildings to the 4 September 2010 and 22 February 2011 earthquake events

Detailed strong motion data was available from recording stations in Canterbury for the 4 September 2010 earthquake, and the 26 December 2010 and 22 February 2011 aftershocks. Figure 4.6 shows the location of the investigated buildings, labelled “P”, “F”, “H” and “C”, and the four nearest recording stations. There was a fifth recording station close to the CTV site, but records for the Lyttelton aftershock were not available from this site.

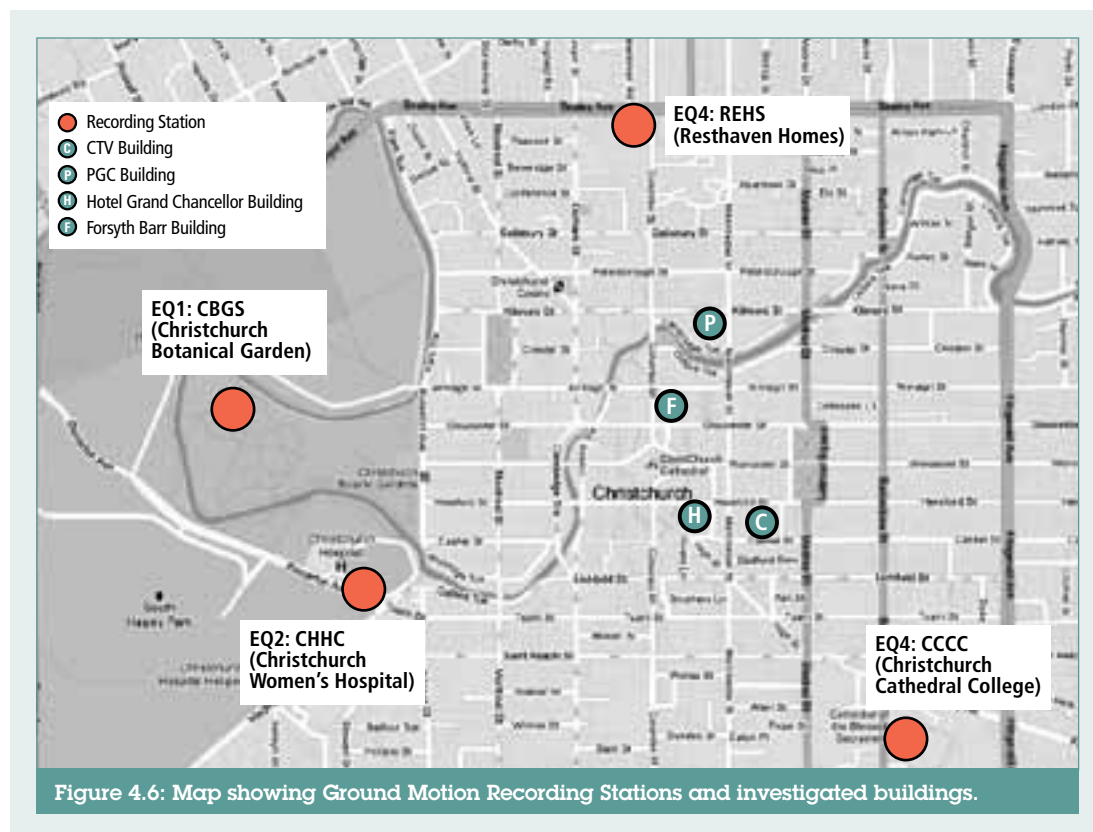

## 4.0 CONTEXT

Indications are that the ground shaking in the CBD on 22 February 2011 was sufficient to cause building responses comparable to those used for the design of modern buildings. However, the correlation between ground motion and real building response is still a matter of ongoing research. Given the level of expected building response to ground shaking, and the continuous evolution of building codes in the past decades, it is not surprising that many of the multi-storey post-1960 buildings in the CBD suffered significant structural damage in the 22 February 2011 event.

Figure 4.7 and Figure 4.8 show plots of *spectral (building) acceleration* against *(building) period* for the 4 September 2010 and 22 February 2011 events.

The figures are taken from a contextual report prepared for the Department<sup>1</sup> and are reproduced here in order to illustrate the special challenges involved in estimating the response of any building to a particular earthquake.

These acceleration-versus-period plots are used by structural engineers to assess the likely earthquake response of buildings of different types and sizes. The vertical axis shows the (estimated) maximum acceleration of a building in response to specified ground motions. The horizontal axis shows the period (natural period of vibration) of a range of buildings. The period increases with the height of the building and varies with building type. Low height (stiffer) buildings have shorter periods. Taller buildings have longer periods. The estimated periods for the buildings in this investigation range from 0.7 seconds for the PGC Building to 2.4 seconds for the Forsyth Barr Building.

The figures include estimated responses to measured ground accelerations at four different measurement stations, in or near the CBD. These values may be thought of as a measure of the structural "demand" placed on buildings for a range of periods (heights/stiffnesses) as a result of the ground shaking. It can be seen that these demands vary greatly between one recording station and another and that they vary significantly with building period.

The bold lines represent design levels used for Christchurch buildings according to the 2004, 1984 and 1976 standards. Two intensity levels are considered for the most recent (2004) loading standard, the design level (or 500 year event) and the Maximum Considered Earthquake (assumed as 1.8 times the design level and approximately corresponding to a 2500 year event).

<sup>1</sup> Kam, W.Y., Pampanin, S., 2011 *General Performance of Buildings in Christchurch CBD after the 22 Feb 2011 Earthquake: a Contextual Report*, Department of Civil and Natural Resources Engineering, University of Canterbury, November 2011.

## 4.0 CONTEXT

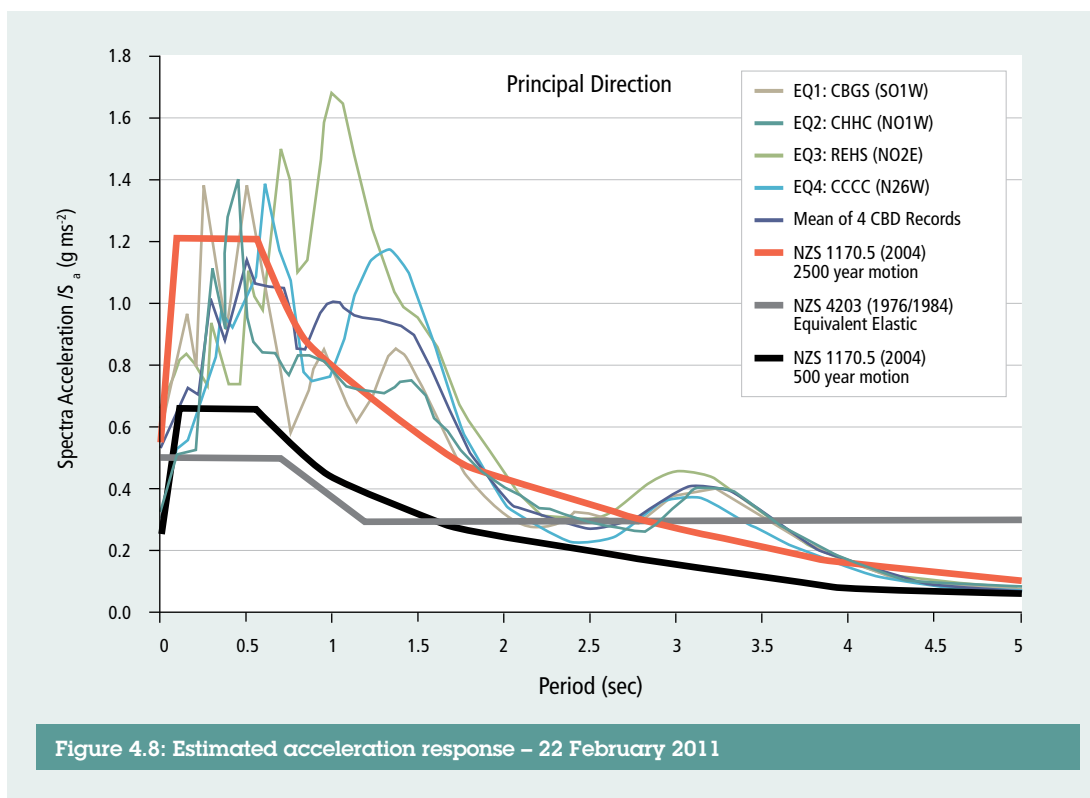
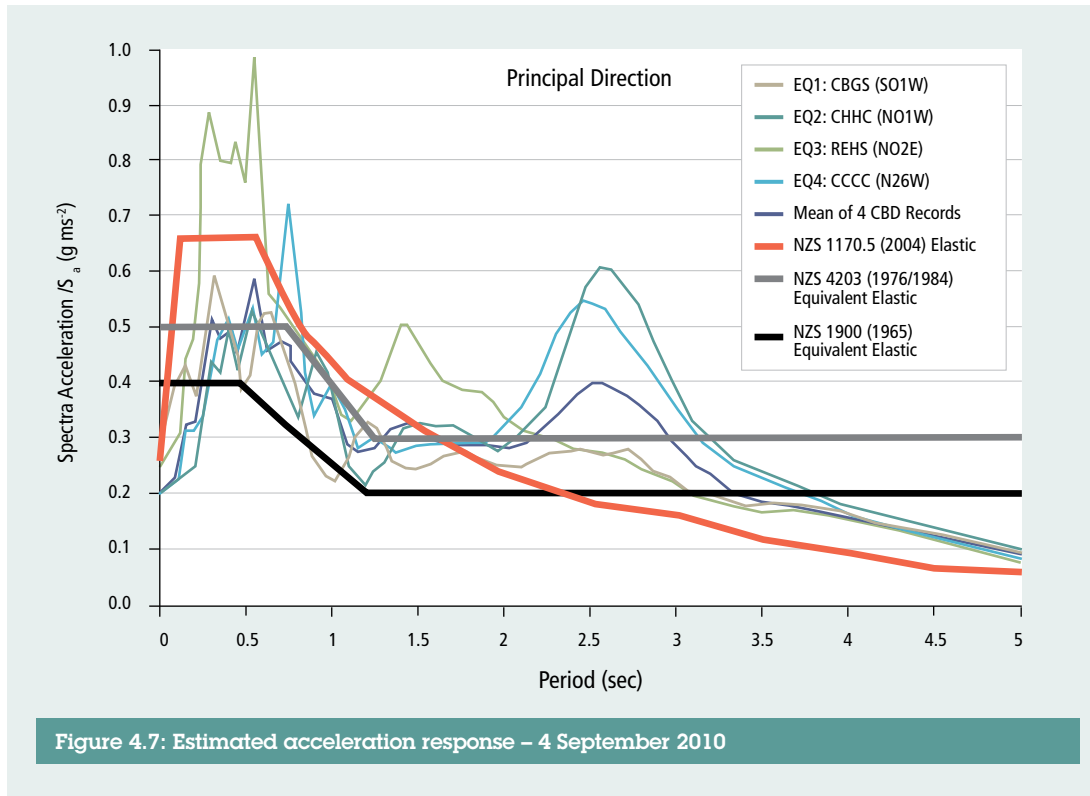

## 4.0 CONTEXT

### 4.3.3 Comparison with design levels

Figure 4.9 and Figure 4.10 provide a general comparison of the relative demands of the 4 September 2010 and 22 February 2011 events. In order to provide a comparison of the demand of the 22 February 2011 aftershock and the various design plots, the plots from the ground shaking records have been shown as a broad grey band on each figure. They are plotted as wide bands to indicate the variability of response within any one record and between one recording station and another.

The curved red line in Figure 4.9 represents the “design” level (1-in-500 year) for most modern buildings in Christchurch – the 2004 standard. This curve is derived using a range of estimated ground accelerations of different types and then representing the responses as a single line. The line shown assumes that the structure has been designed to respond elastically to the 1-in-500 year event and does not yield (“equivalent elastic”). This makes it comparable with the demand curves derived from the ground motion records from the nominated stations.

For design purposes ductile detailing is used and the acceleration values (hence the lateral forces used in design) are reduced accordingly, typically by a factor of five. Importantly, such a reduction in force level brings with it an obligation to detail the structural elements (beams, columns and walls) to achieve the level of ductility assumed in making the force reduction.

In a similar way, the blue line represents the design level for the 1984 and 1976 standards. Once again, these show the “equivalent elastic” response values so that they are comparable with the accelerations derived from the ground motion records. Designs to these standards allow the accelerations to be reduced if ductility is provided in the design detailing.

For the 1976, 1984 and 2004 standards the “equivalent elastic” curves represent the design performance level expected, because any reduction in the acceleration values used in design were compensated for by requirements for ductile detailing. This was not the case for the 1965 standard. Under that standard, design accelerations used assumed that ductility was achieved, but there were no specific detailing requirements. This makes comparison with modern standards more difficult.

The green lines in Figure 4.9 and Figure 4.10 indicate design requirements for the 1965 standard. The upper solid green line represents the performance of a building designed to this standard in which full ductility is achieved. The lower dashed green line represents a building designed to the 1965 standard in which no ductility is achieved. In fact, buildings designed to the 1965 standard will vary in levels of ductility achieved, so that the performance of a building built between 1965 and 1976 would be somewhere between the two green lines. The situation with any one building requires knowledge of its structural form and the level of ductility achieved through the detailing of structural elements.

It can be seen that buildings designed to the 1965 standard that achieve the higher levels of ductility plot significantly below the 1976 and 1984 standards, and well below current standards for periods up to 1.5 seconds. For taller (higher period) buildings the 1965, 1976 and 1984 standards are greater than the 2004 requirements.



## 4.0 CONTEXT

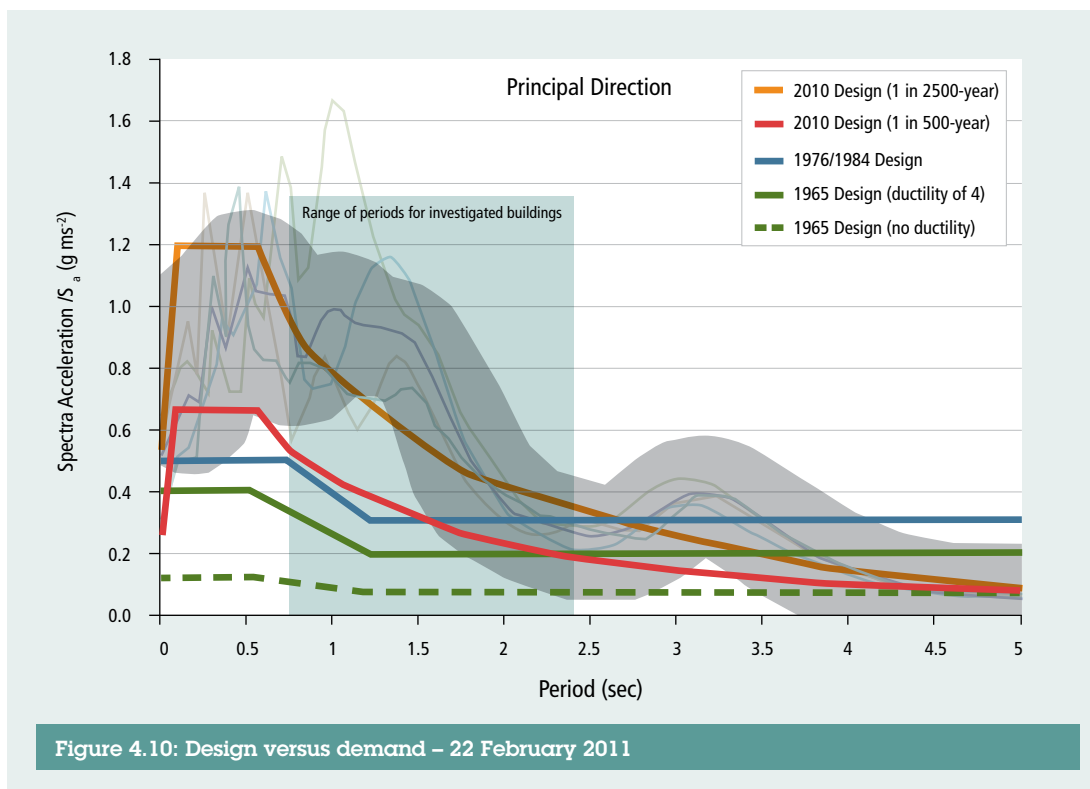
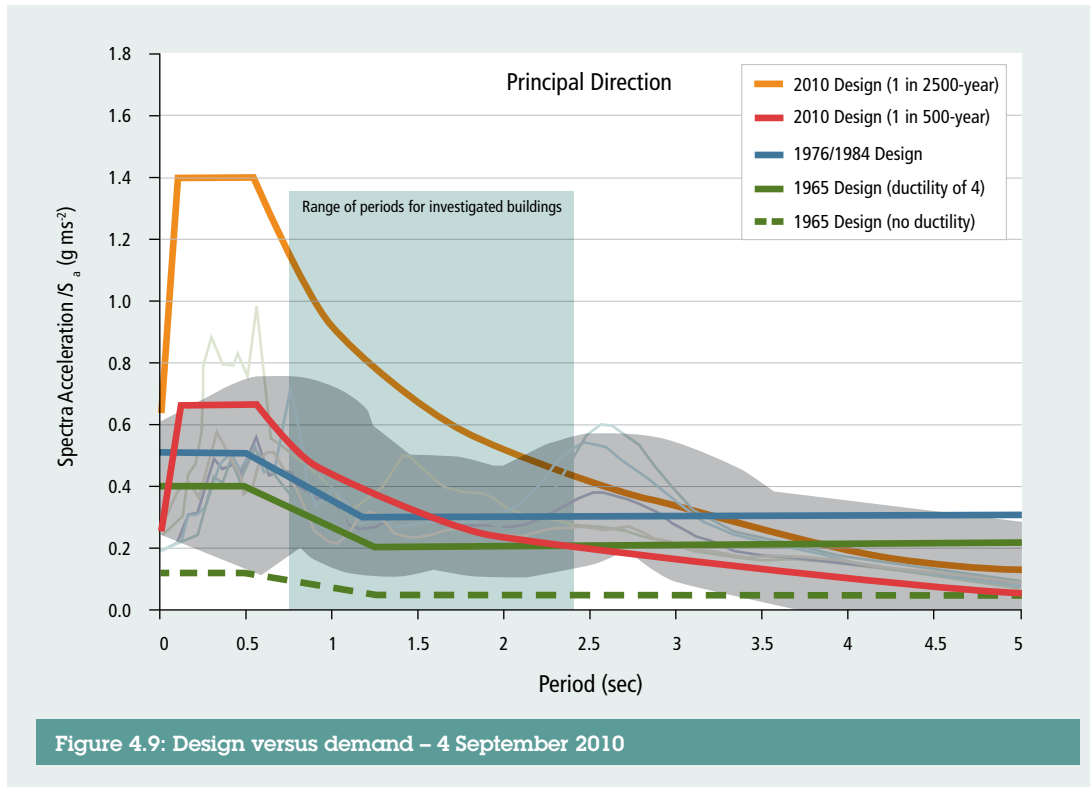

## 4.0 CONTEXT

Comparison of the various design levels with the demand “band” is clear in these modified figures. For the 4 September 2010 event, it can be seen that demand is broadly comparable to capacity, particularly when it is considered that a building designed to the standard is highly likely to have an actual capacity greater than indicated by the design-level line. Conservative assumptions built into the structural design process mean that very few buildings would be expected to perform below the prescribed level for design.

The exceptional demands of the 22 February 2011 event are clear from Figure 4.10 where the grey band is well above the red line (representing design for a 1-in-500-year ground shaking level to the 2004 standard). The higher orange line represents design for a 1-in-2500-year ground shaking level.

### 4.3.4 Limitations in the comparisons

The variability evident in the above figures indicates the challenges in determining the causes of failures in particular buildings in a real earthquake. But even these estimates are based on certain assumptions as to the properties of the building, notably that it will respond elastically and have defined response characteristics. In addition, for a particular building, the alignment of the building with the direction of the strongest earthquake shaking provides further challenges and uncertainties in the estimation of its response.

When relating the measured ground accelerations to a particular building site, differences in soil profile may change the characteristics of the ground shaking, and thus the building response.

There is thus considerable debate amongst engineers about interpreting recorded ground motion information and likely building response. Structures are designed using “conservative” assumptions. The level of demand (such as earthquake shaking) is taken so that there is a low probability of it being exceeded. At the same time estimates of structure capacity (or strength) are based on material properties that have a low probability of being less than the values used. This approach aims to result in a very low probability that demand will exceed capacity.

### 4.3.5 Non-linear analysis

One tool that has helped in this investigation is non-linear time history analysis (NTHA). In this technique, which is also referred to as inelastic time history analysis (ITHA) or NLTHA, the building is not assumed to respond elastically, and this more realistically reflects actual behaviour. The measured ground motions, horizontal and vertical, are used as input and the response of the building is calculated taking account of any change in properties as the building deforms. For example, the stiffness (or period of vibration) of a building changes as the building deforms and various members yield (ie deform inelastically). Figure 4.9 and Figure 4.10 above do not take this into account and it is clear from these figures that even small modifications in period can make a large difference to the building response.

While NTHA brings its own uncertainties and variability issues, it is recognised as providing a more realistic estimate of building response than elastic analyses provide.

Although there is more scope for interpretation, NTHA analyses completed for the PGC and CTV buildings correlate reasonably with the lack of significant damage on 4 September 2010, while similar analyses using the 22 February 2011 ground motion records clearly point to the demand exceeding capacity.

## 4.0 CONTEXT

### 4.3.6 General variability of building performance in earthquakes

It is important to recognise that the estimation of building response to a particular earthquake is subject to considerable variability and uncertainty. Responses quoted in the accompanying consultants' reports should be interpreted in this light. Quoted values of force or displacement, although they give a good indication of likely values, could nevertheless vary quite significantly from those experienced by the building.

In a broader sense, this variability helps to explain why buildings designed and built to meet the same requirements can suffer markedly different levels of damage. The conservatism built into structural design processes means that most buildings designed to a defined standard will, in reality, exceed that defined standard. Furthermore, most buildings are the first (and often the only) one of their kind and this introduces significant variation into the performance of buildings, even between those of identical design. It is the combined variation in both demand and capacity that explains, in general terms, why some buildings fare much worse, or better, than others, or why one building collapses and another similar building does not.

A further factor that can influence the overall structural performance in earthquakes is the duration of shaking. Intense shaking for a relatively short time may do less damage than shaking of less intensity that lasts longer. For example, it is expected that the strongest shaking in Christchurch due to a larger Alpine Fault earthquake would be of lower intensity than the 22 February 2011 aftershock, but would last longer.

### 4.3.7 Contextual Report

Further details on the context of the Canterbury earthquakes are given in the Contextual Report by Pampanin and Kam – see Appendix H for the report reference. In particular, this report describes typical damage to a range of different building types. In so doing, it provides evidence that the four buildings that are the subject of this investigation were not the only buildings to be seriously impacted by the 22 February 2011 aftershock.

For ease of reference, the cover and contents list of the Contextual Report is provided in Appendix H.

## 5.0

# Canterbury Television Building

## 5.1 Overview

The six-level Canterbury Television (CTV) Building located at 249 Madras Street, Christchurch suffered a major structural collapse on 22 February 2011 following the Magnitude 6.3 Lyttelton aftershock. Shortly after the collapse of the building a fire broke out in the stairwell and continued for several days.



Figure 5.1: Canterbury Television Building in 2004 (Photo credits: Phillip Pearson, derivative work: Schewede66)

The investigation has shown that the CTV Building collapsed because earthquake shaking generated forces and displacements in a critical column (or columns) sufficient to cause failure. Once one column failed, other columns rapidly became overloaded and failed.

## 5.0 CANTERBURY TELEVISION BUILDING

Factors that contributed (or may have contributed) to the failure include:

- higher than expected horizontal ground motions
- exceptionally high vertical ground motions
- lack of ductile detailing of reinforcing steel in all columns
- low concrete strengths in critical columns
- interaction of perimeter columns with the spandrel panels
- separation of floor slabs from the north core
- accentuated lateral displacements of columns due to the asymmetry of the shear wall layout
- accentuated lateral displacements between Levels 3 and 4 due to the influence of masonry walls on the west face
- the limited robustness (tying together of the building) and redundancy (alternative load paths) which meant that the collapse was rapid and extensive.

A number of key vulnerabilities were identified which affected the structural integrity and performance of the building. These included: high axial loads on columns; possible low concrete compression strength in critical columns; lack of ductile detailing and less than the minimum shear reinforcing steel requirements in columns; incomplete separation between in-fill masonry and frame members in the lower storeys on the west wall; and the critical nature of connections between the floor slabs and north structural core walls.

Examination of building remnants, eye-witness reports and various structural analyses were used to develop an understanding of likely building response. A number of possible collapse scenarios were identified. These ranged from collapse initiated by column failure on the east or south faces at mid to high level, to collapse initiated by failure of a more heavily loaded internal column at mid to low level. The basic initiator in all scenarios was the failure of one or more non-ductile columns due to the forces induced as a result of horizontal movement between one floor and the next. The amount of this movement was increased by the plan irregularity of the lateral load resisting structure. Additional inter-storey movement due to possible failure prior to column collapse of the connection between the floor slabs and the north core may have compounded the situation.

The evaluation was complicated by the likely effect of the high vertical accelerations and the existence of variable concrete strengths. It was further complicated by the possibility that the displacement capacities of columns on the east or south faces were reduced due to contact with adjacent spandrel panels. Many reasonable possibilities existed. In these circumstances it has been difficult to identify a specific collapse scenario with confidence.

The most studied collapse scenario, which was consistent with the arrangement of the collapse debris and eye-witness reports of an initial tilt of the building to the east, involved initiation by failure of a column on the mid to upper levels on the east face. Inter-storey displacements along this line were higher than most other locations and there was the prospect of premature failure due to contact with the spandrel panels. For this scenario, it was recognised that contact with the spandrel panels would have reduced the ability of the column to carry vertical loads as the building swayed. However, the displacement demands of the 22 February 2011 event were such that column failure could have occurred even if there had been no contact with the spandrels. Loss of one of these columns on the east face would have caused gravity load to shift to the adjacent interior columns. Because these columns were already carrying high vertical loads and were subjected to lateral displacements, collapse would have been likely.

The low amount of confinement steel in the columns and the relatively large proportion of cover concrete gave the columns little capacity to sustain loads and displacements once strains in the cover concrete reached their limit. As a result, collapse was sudden and progressed rapidly to other columns.

Once the interior columns began to collapse, the beams and slabs above fell down and broke away from the north core. The south wall, together with the beams and columns attached to that wall, then fell northwards onto the collapsed floors and roof.

## 5.0 CANTERBURY TELEVISION BUILDING

Other scenarios considered had different routes to the failure of a critical column, including scenarios involving diaphragm disconnection from the north core. In all cases, once the critical column failed, failure of other columns followed.

### 5.2 Investigation

A technical investigation into the reasons for the collapse was commissioned by the Department of Building and Housing and was undertaken by Hyland Consultants Limited and StructureSmith Limited.

The investigation consisted of:

- examination of the remnants of the collapsed building
- review of available photographs
- interviews with surviving occupants, eye-witnesses and other parties
- review of design drawings and specification for the original work and structural modifications
- structural analyses to assess the demand on and capacity of critical elements
- synthesis of information to establish the likely cause and sequence of collapse.

A separate report covering the Site Examination and Materials Testing undertaken for the investigation was prepared by Hyland Consultants Limited.<sup>2</sup>

### 5.3 Building description

The developer of the building gained a building permit from the Christchurch City Council in September 1986, and construction progressed through 1986 and 1987. The structure of the CTV Building was rectangular in plan, and was founded on pad and strip footings bearing on silt, sand and gravels. Lateral load resistance was provided by reinforced concrete walls surrounding the stairs and lifts at the north end, and by a reinforced concrete wall on the south face. Refer to Figure 5.1 and Figure 5.2. On the west face, reinforced concrete block walls were built between the columns and beams for the first three levels. Reinforced concrete spandrel panels were placed between columns at each level above ground floor on the south, east and north faces. Spandrel panels perform various functions including fire protection, sun control and architectural design.

The reinforced concrete floors were cast in-situ on permanent metal forms. The slabs were supported by reinforced concrete beams around the perimeter and internally, running in the east-west direction. The beams were, in turn, supported principally by circular reinforced concrete columns.

The building was designed with ductile reinforced concrete shear walls and with a lightweight roof supported on steel framing above Level 6. The walls of the north core and south wall were designed to provide all the lateral stability needed for earthquake actions. As such, they were required to be stiff and ductile. The columns (and the frames formed by columns and beams) were designed to carry gravity loads only on the basis that the lateral displacements of these gravity elements would then be restricted by the stiff wall elements. Provided the walls were designed to keep displacements within prescribed limits, the beams and columns were not required to be detailed to behave in a ductile manner.

The CTV Building was originally designed as an office building but changed use over time to include an education facility and radio and television studios for Canterbury Television.

Note that the six floor levels are numbered with the ground floor being Level 1 for the CTV Building. Refer to Figure 5.1.

Grid line locations are defined in Figure 5.2.

<sup>2</sup> Report to the Department of Building and Housing on CTV Building Site Examination and Materials Tests, Hyland Fatigue and Earthquake Engineering (January 2012).

## 5.0 CANTERBURY TELEVISION BUILDING

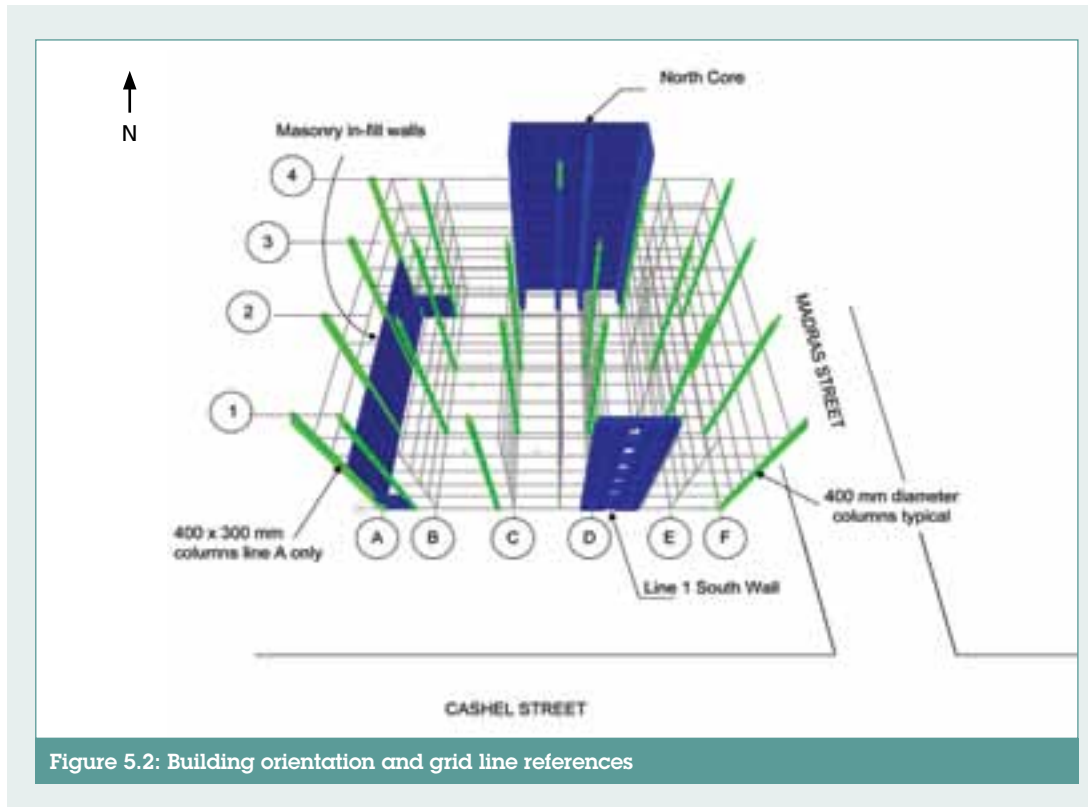

Figure 5.2: Building orientation and grid line references

## 5.4 Structural modifications

Following an independent consulting engineer's pre-purchase review in January 1990, drag bars were designed by the design engineer in October 1991 and subsequently installed at Levels 4, 5 and 6 to improve the connections between the floor slabs and the walls of the north core (refer to Figure 5.7). These connections were vital to the integrity of the building since the walls provide lateral stability and strength to the building.

Other structural modifications to the building included the formation of a stair opening in the Level 2 floor next to the south wall. Coring of the floors for pipes was found to have occurred at the locations where the slab pulled away from the lift core during the collapse. However, neither the stair opening nor the coring of floors appears to have been a significant factor in the collapse on 22 February 2011.

## 5.0 CANTERBURY TELEVISION BUILDING

# 5.5 Earthquake and other effects prior to 22 February 2011

## 4 September 2010

Damage to the CTV Building structure was observed and reported after the 4 September 2010 earthquake, as follows:

- Minor cracking to the south wall and adjacent floors.
- Minor structural damage including fine shear cracks in the north walls.
- Fine cracking of several perimeter columns in the upper floors.
- Several cracked or broken windows
- Floor to ceiling cracks at the junction of the lift doors wall and return walls on Level 6.

This reported damage appeared to be relatively minor and was not indicative of a building under immediate distress or having a significantly impaired resistance to earthquake shaking.

## Demolition of neighbouring building

The building next door to the CTV Building began to be demolished almost immediately after the 4 September 2010 earthquake and demolition continued until a week before the 22 February 2011 aftershock. The demolition work caused noticeable vibrations and shuddering in the CTV Building which was a significant concern to the tenants. The view of the investigation team, based on a general description of the demolition operation and photos of the demolition process, was that the demolition would have been unlikely to have caused significant structural damage to the CTV Building.

## 26 December 2010

Eye-witnesses advised of no significant structural damage but some non-structural damage after the 26 December 2010 aftershock. There were no available reports on the condition of the building after this event, but photographs of this damage indicate that it was minor.

# 5.6 Collapse on 22 February 2011

The 22 February 2011 aftershock caused the sudden and almost total collapse of the CTV Building. Shortly after the collapse of the building a fire broke out in the stairwell and continued for several days.

It is evident that the building collapsed straight down almost within its own footprint and that the south wall (with stairs attached) fell on top of the floor slabs. The north core remained standing after the collapse.

Eye-witnesses spoken to as part of the investigation saw the building sway and twist violently. One, with a view of the south and east faces, described the whole exterior exploding and seeing the cladding failing and falling, and columns breaking. The upper levels of the building were seen to tilt slightly to the east and then come down as a unit on the floors below. The building appeared to collapse in on itself and this was confirmed by the final position of the collapsed slabs and the fact that external south face framing collapsed on top of the floor slabs.



## 5.0 CANTERBURY TELEVISION BUILDING

### 5.7 Eye-witness accounts

Interviews were conducted with 16 eye-witnesses to the CTV Building collapse in order to identify consistent qualitative observations about the collapse. Four of the eye-witnesses interviewed were inside the CTV Building at the time of collapse and 12 were in the street or in other buildings next door with a clear line of sight to portions of the CTV Building as it collapsed. These insights provided clues to what actually happened to the structure of the building in the collapse event.

Although eye-witnesses interviewed in the investigation gave varying responses on the speed of collapse of the CTV Building, the majority felt it went down in a matter of seconds. Eye-witnesses gave a range of responses on the speed of collapse, including responses such as “it crumbled in seconds”, there was “only five seconds warning from the time the earthquake hit”, and it came “down in 30 seconds or quicker”. Where timing was mentioned, eye-witness responses referred to seconds rather than minutes for the collapse to occur.

### 5.8 Examination of collapsed building

#### Inspections and photographs

The examination of the collapsed building involved physical examination of the Madras Street site including the north core, and examinations of the columns that had been extracted from the building and taken to a secure area at the Burwood Eco Landfill. Photographs of the collapse taken by the public prior to debris being removed, and by rescue agencies and the media during the removal of debris, were used to help ascertain the likely collapse sequence and behaviour of the CTV Building.

A review of photographs taken by rescue agencies as debris was removed provided valuable information on the sequence of the collapse.

#### Site examination and materials testing

Following the completion of rescue and recovery efforts, the Madras Street site was examined and material samples collected and tested. Columns at the Burwood Eco Landfill were also extracted and tested. Care was taken to select samples that were not affected by the post-earthquake fire and which were away from clearly damaged areas.

Materials testing was conducted on reinforcing steel, wall concrete, slab concrete and beam concrete to assess compliance with standards of the day. The main findings from this testing included the following:

- All reinforcing steel appeared to conform to the standards of the day.
- Concrete strengths in concrete from south wall and north core wall samples were found to be greater than specified.
- Tests on 26 column samples (21% of all CTV Building columns) indicated that, at the time of testing, the column remnants from Levels 1 to 6 had a mean concrete strength of 29.6 MPa, with measurements ranging from 17.3 MPa to 50.3 MPa.

The position in relation to the column samples is summarised in Figure 5.3. The black line indicates the inferred distribution of concrete strengths from the tests. The other three distributions are the expected strength distributions at 28 days from pouring of concrete based on the specified concrete strengths (after 28 days) which were 35 MPa for Level 1 columns, 30 MPa for Level 2, and 25 MPa for Levels 3 to 6. Even though it is not known which of the measurements applies to which expected strength distribution, it can be seen that a higher than expected proportion of the results is below the specified level in all cases.

## 5.0 CANTERBURY TELEVISION BUILDING

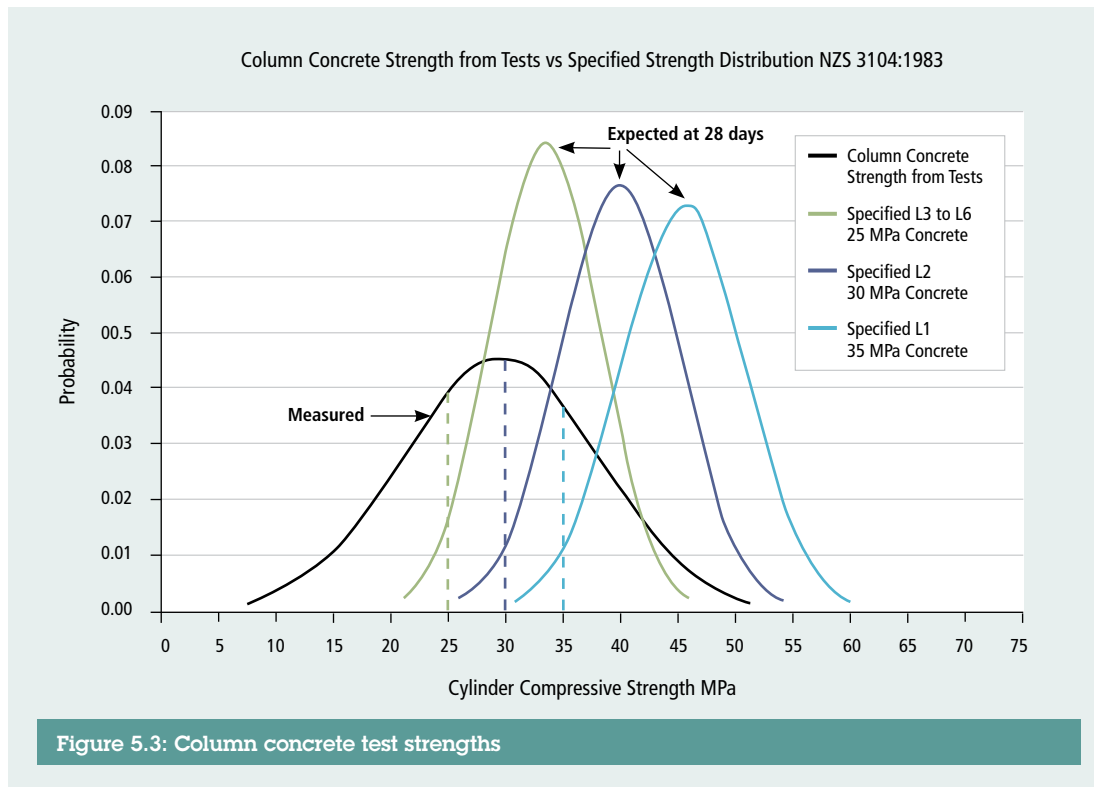

While it is recognised that the tests were conducted on members that had been involved in the collapse, the results indicate that column concrete strengths were significantly less than the expected strength considering the specified strengths, the conservative approach to achieving specified strengths, and the expected strength gain with age.

## 5.9 Collapse evaluation

### Approach and limitations

The aim of the evaluation was to identify, if possible, the most likely collapse scenario. The results of the structural analyses undertaken were considered in conjunction with information available from eye-witness accounts, photographs, physical examinations and selective sampling and testing of remnants.

The analyses were needed to develop an understanding of the likely response of the building to earthquake ground motions and the demands this response placed on key structural components. It was recognised that any analyses for the 22 February 2011 event must be interpreted in the light of the observed condition of the CTV Building after the earthquake on 4 September 2010 and the 26 December 2010 aftershock, and the possibility that these and other events could have affected the structural performance of the building.

Elastic response spectrum analyses (ERSA) were undertaken similar to those required by the design standards of the time (NZS 4203:1984 and NZS 3101:1982) and also using levels of response corresponding to the ground motion records. These analyses provided insights into the design intentions and the likely response of the building in the 4 September 2010, 26 December 2010 and 22 February 2011 events.

## 5.0 CANTERBURY TELEVISION BUILDING

Non-linear time history analyses (NTHA) were undertaken using actual records of the 4 September 2010 earthquake and the 22 February 2011 aftershock from other nearby sites. The response of the CTV Building to these ground motions and the structural effects on critical elements, particularly the columns and floor diaphragm connections, was assessed.

The approach taken was to:

- carry out a number of structural analyses of the whole building to estimate the demands (loads and displacements) placed on the building by the earthquakes
- evaluate the capacities (ability to resist loads and displacements) of critical components such as columns
- compare the demands with the capacities to identify the structural components most likely to be critical
- identify likely collapse scenarios taking account of other information available.

Structural analyses and evaluation included:

- elastic response spectrum analyses (ERSA) of the whole building
- non-linear static pushover analyses of the whole building
- non-linear time history analyses (NTHA) of the whole building
- elastic and inelastic analyses of the easternmost frame (Line F).

The demands from these analyses were compared with the estimated capacities of critical elements to assess possible collapse scenarios and to reconcile the results of the analyses with the as-reported condition of the building on 4 September 2010.

Overall, the approach for the analyses was to:

- use established techniques to estimate structural properties and building responses
- use material properties which were in the middle of the range measured
- examine the effects of using ground motions (or response spectra records derived from them) from several recording stations
- apply these ground motions or response spectra without modifying their nature or scale
- consider the variability and uncertainties involved in each case when interpreting results of the analyses or comparisons of estimated demand with estimated capacity.

The characteristics of the building and the information from inspections and testing required consideration of a number of possible influences on either the response of the building or the capacities of elements, or both. Principal amongst these were the following:

- The masonry wall elements in the western wall (Line A) up to Level 4 may have stiffened the frames.
- The concrete strength in a critical element could vary significantly from the average values assumed for analysis.
- The spandrel panels on the south and east faces of the building may have interacted with the adjacent columns.
- The floor slabs may have separated from the north core.

On top of this, consideration needed to be given to the variability and uncertainties inherent in structural analysis procedures. In this case, particular consideration was given to the following:

- The possibility that the ground motions or elastic response spectra used in the analyses may have differed significantly in nature and scale from those actually experienced by the building.
- The stiffness, strength and non-linear characteristics of structural elements assumed for analysis may have differed from actual values. This possibility can result in differences from reality in the estimated displacements of the structure and/or the loads generated within it.
- Estimating the effects on the structure of the very significant vertical ground accelerations was subject to considerable uncertainty.

## 5.0 CANTERBURY TELEVISION BUILDING

In summary, the analyses were necessarily made with particular values, techniques and assumptions, but the above limitations were considered when interpreting the output. It should be evident that determination of a precise sequence of events leading to the collapse is not possible. Nevertheless, every effort was made to narrow down the many options and point towards what must be considered a reasonable explanation even though other possibilities cannot be discounted.

Overall, the output of the NTHA analyses was not inconsistent with the reported condition of the building after 4 September 2010. The limited available evidence of the building condition after 4 September 2010 leaves room for a range of interpretations of the likely maximum displacements in the 4 September 2010 event. However, the conclusions drawn from the analyses are not particularly sensitive to the level of demand assumed by the NTHA, with indications that collapse could have occurred at lower levels of demand.

Comparisons of demand and capacity of structural elements have been made with general acknowledgement of the possibility that the actual building response may have differed from that calculated in any analysis.

The Panel supports the general conclusions as to the reasons for the collapse of the CTV Building. However, because of the range of factors noted above which are subject to variability and uncertainty, there was considerable debate between Panel members and the consultants on the relative weight that should be given to each of those factors. Although in agreement on the key outcomes, some Panel members and the consultants are not of one mind in relation to some of the detail presented in the consultants' report, particularly some detailed technical issues relating to the ERSA and NTHA analyses, the identification of critical columns, the extent of influence of the spandrel panels, and the timing of any separation that may have occurred between the floor slabs and the north core.

### Soils and foundations

Surveys of the site after the collapse indicated that there had been no significant vertical or horizontal movement of the foundations. There was no evidence of liquefaction within the site. Soil and foundation elements were modelled in the structural analyses based on specialist geotechnical advice.

### Ground shaking records for analyses

For the non-linear time history analyses, seismic ground motions at the CTV site were deduced from four strong-motion recordings surrounding the CBD, as follows:

- Botanical Gardens – CBGS
- Cathedral College – CCCC
- Christchurch Hospital – CHHC
- Rest Home Colombo Street – REHS.

The NTHA analyses were carried out using records from the CBGS, CCCC and CHHC sites so as to provide some indication of the effects of variability in ground shaking. While the REHS record showed significantly higher amplification than the others, both with respect to Peak Ground Accelerations (PGA) and spectral accelerations (building response), the soil profile was markedly different from that at the CTV site. The sites of the other three stations (CBGS, CCCC, CHHC) were considered to have generally similar soil profiles to the CTV site, consisting of variable silts, silty sands and gravels overlying dense sands. Geotechnical specialists recommended that the REHS record be disregarded and that the CTV site response be taken as similar to the average of the other three stations.

## 5.0 CANTERBURY TELEVISION BUILDING

For the elastic response spectrum analyses, spectra were developed for the September, December and February events using the closest sites possible at the time with compatible geotechnical conditions. These included the Westpac building and the Police Station, CHHC and CCCC. The average of the resultant response at each period of vibration recorded from the various instruments was used to develop an averaged maximum response spectra for analysis.

### Critical vulnerabilities

Examination of the CTV Building design drawings indicated a number of vulnerable features or characteristics that could have played a part in the collapse. These vulnerabilities, which are outlined below, were the focus of attention during the investigation.

#### Columns

Details of a typical 400mm diameter column are shown in Figure 5.4. Vulnerabilities identified in relation to column structural performance were:

- non-ductile reinforcement details in the columns
- less than required minimum spiral reinforcing for shear strength
- relatively large proportion of cover concrete in the columns
- possibility of significantly lower than specified concrete strength in critical columns
- lack of ductile detailing in beam-column connections.

The lack of ductility in the columns made them particularly vulnerable and they were the prime focus of the analyses. The ability of a column to sustain earthquake-induced lateral displacements depends on its stiffness, strength and ductility. Established methods were used to estimate the capacity of critical columns to sustain the predicted displacements without collapse.

5.0 CANTERBURY TELEVISION BUILDING

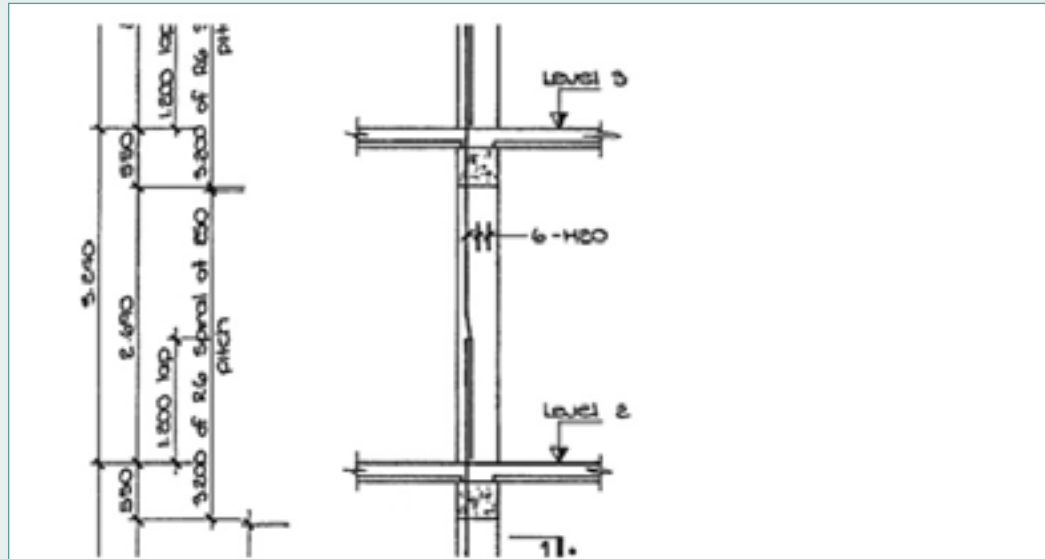

Typical column reinforcing  
(from Design Engineers drawings)

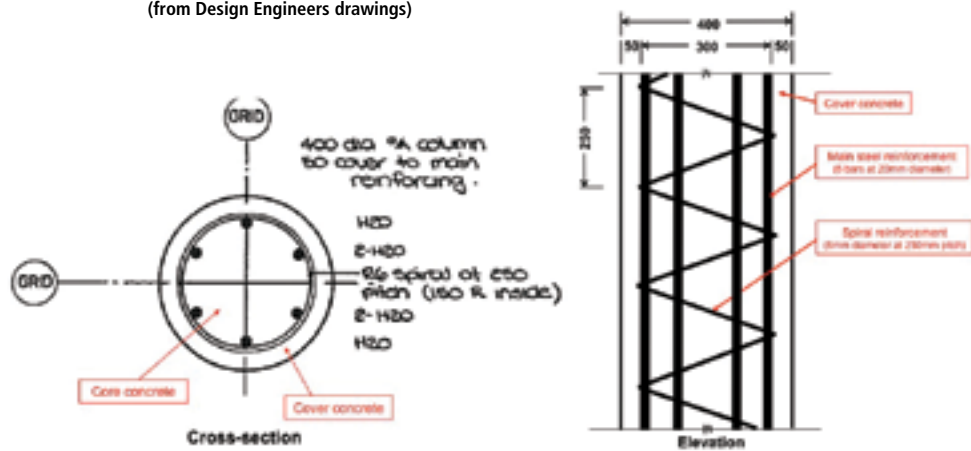

Figure 5.4: Typical 400mm diameter column

## 5.0 CANTERBURY TELEVISION BUILDING

### Spandrel panels

A plan and a cross-section of the typical column and spandrel panel arrangement are shown in Figure 5.5.

The pre-cast reinforced concrete spandrel panels were fixed to the floor slab and were placed between columns. The gap between the ends of adjacent spandrels was specified to be 420mm giving a nominal 10mm gap either side between the spandrel and the column. It is possible that these gaps varied from the nominal 10mm and it is estimated they may have ranged between 0 and 16mm. It is not known what the sizes of the gaps actually were, but analyses showed a significant reduction in column drift capacity for the case where no gap was achieved. Forensic evidence indicated that interaction may have occurred between some columns and adjacent spandrel panels in the 22 February 2011 event. There were also indications of cracking reported in some of the upper level columns after the September earthquake that may have indicated some interaction with the spandrel panels.

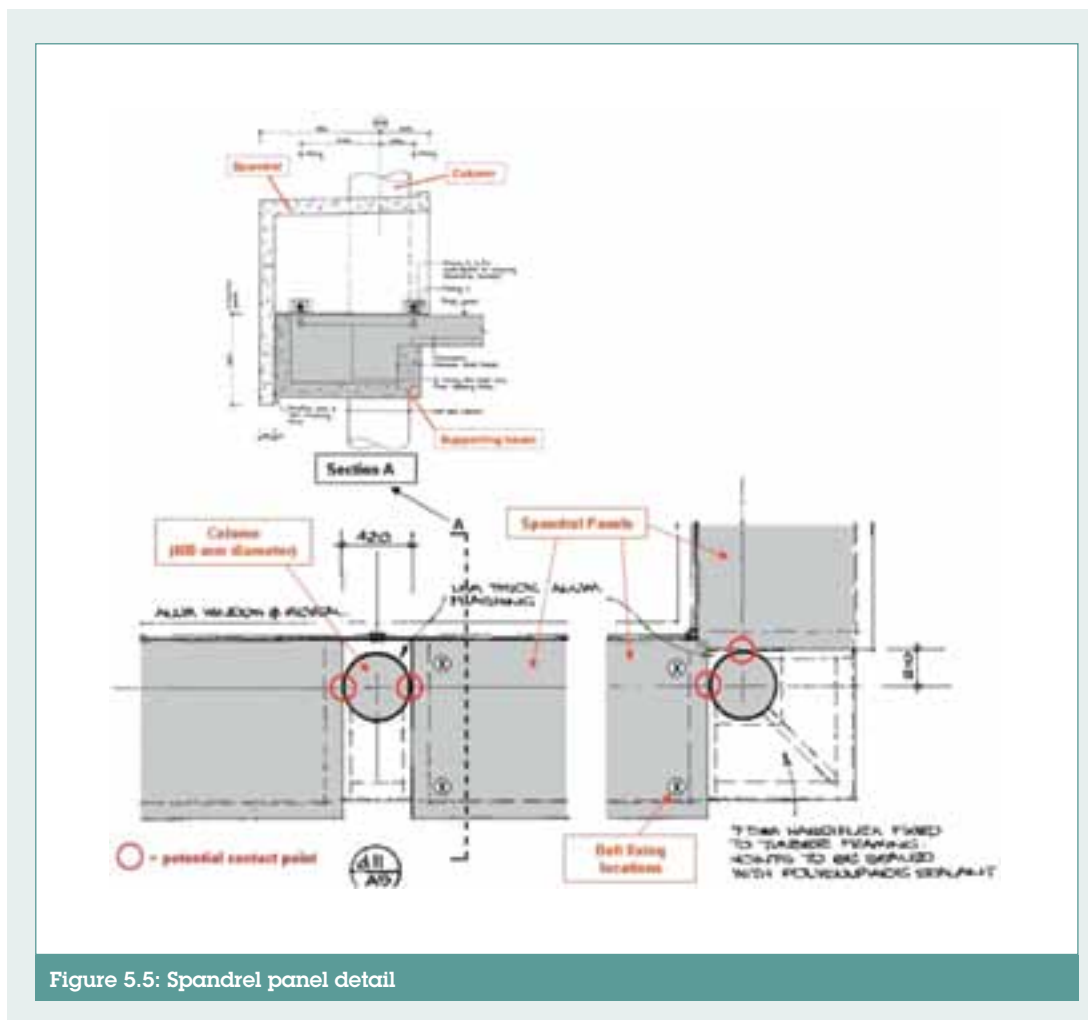

Figure 5.5: Spandrel panel detail

### Irregularities/lack of symmetry

Potential vulnerabilities identified were:

- lack of symmetry in plan of the concrete shear walls (north core and south wall)
- vertical and plan irregularity due to lack of separation between the frame and masonry infill walls on the west face.

## 5.0 CANTERBURY TELEVISION BUILDING

It was considered that the lack of symmetry in plan could cause displacements on the south and east faces to increase as the building rotated in plan. Figure 5.6 illustrates the results of one examination of this effect. The centre of mass indicates where the lateral forces would act. The centre of rigidity indicates where lateral forces, at Level 4, would be resisted. The horizontal distance between these points is a measure of the tendency of the building to twist when subject to horizontal ground motions.

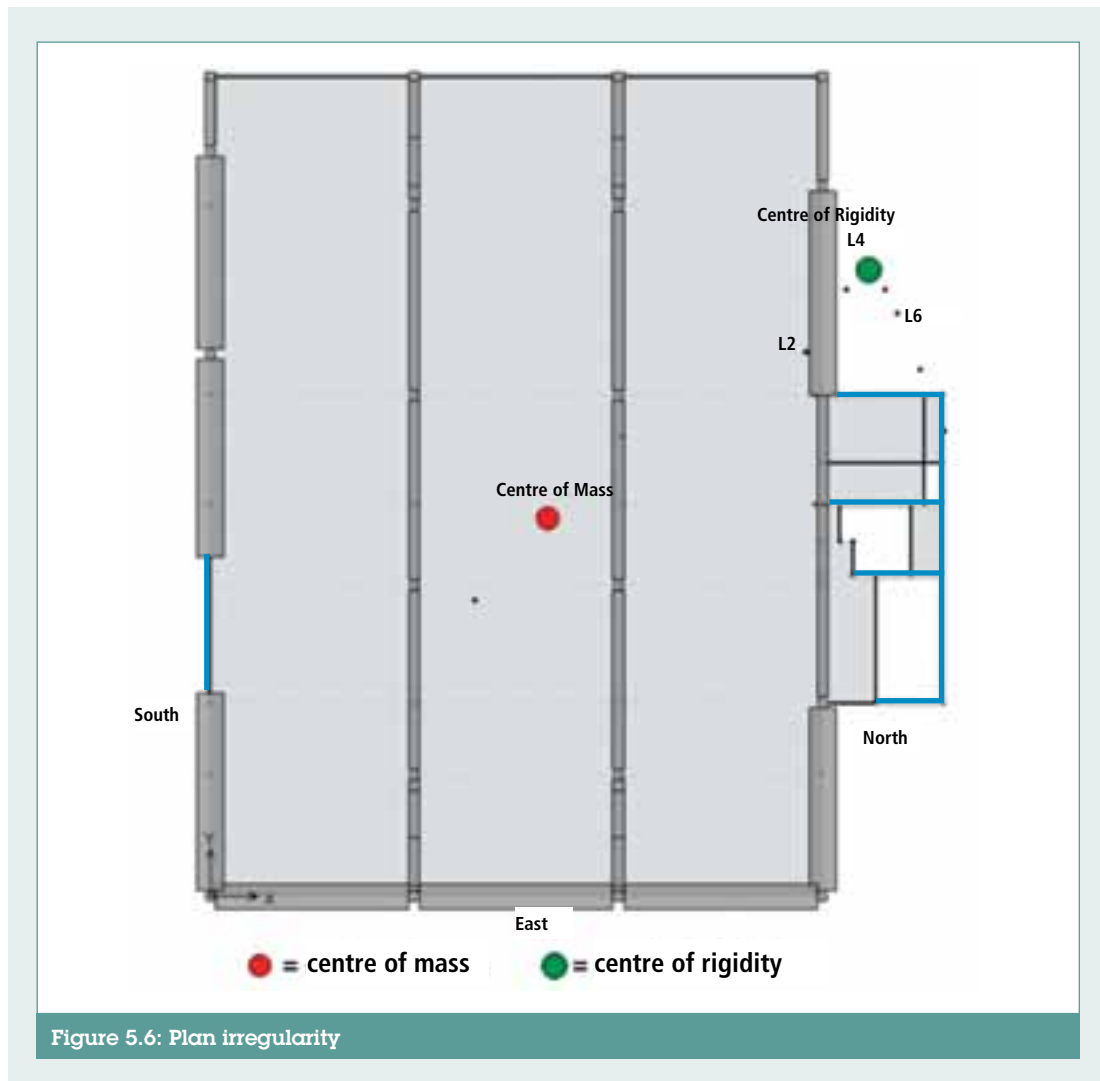

### Diaphragm connection

Figure 5.7 shows plans of the area where a typical floor slab (shaded grey) meets the stabilising walls of the north core (shaded blue). The large lateral forces from the floor slab must be transferred to the walls at the (limited) places where slab and wall elements meet and through the drag bars (shaded red) which were added at Levels 4, 5 and 6 in October 1991. These connections were seen as vulnerable and there was a possibility that the diaphragm (slab) would separate from the walls, resulting in increased lateral displacements and higher demands on critical columns.



## 5.0 CANTERBURY TELEVISION BUILDING

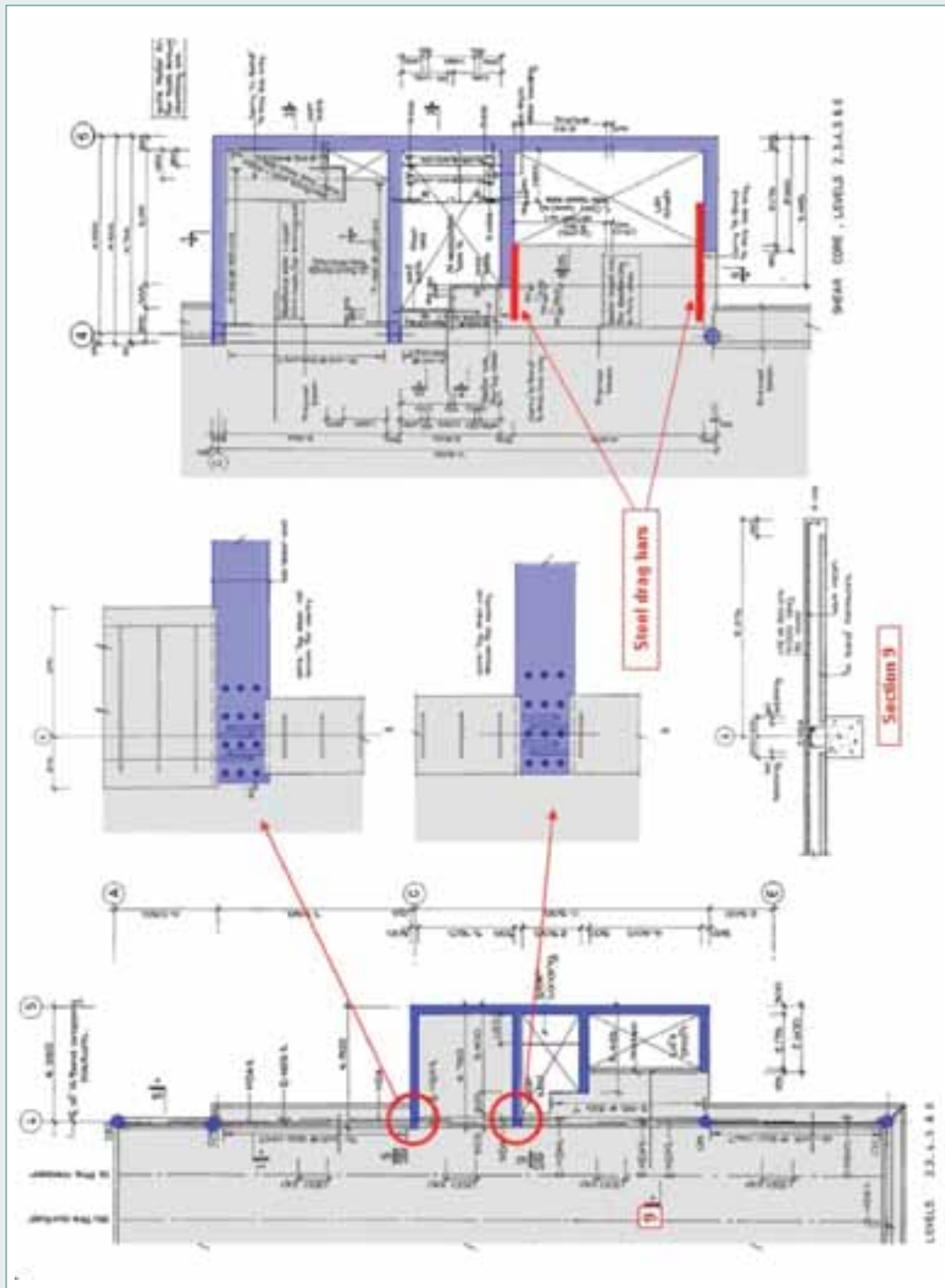

Figure 5.7: Diaphragm connections at north core

## 5.0 CANTERBURY TELEVISION BUILDING

### Collapse initiators examined

Four potential collapse initiation scenarios were identified for evaluation:

1. Column failure on Line F or Line 1. This involved collapse initiation as a result of column failure on one of these lines, probably in a mid to upper level, with or without the influence of spandrel interaction. A Line F initiation was noted as being consistent with the arrangement of the collapse debris and eye-witness reports of an initial tilt to the east.
2. Column failure on Line 2 or Line 3. Collapse in this case would be initiated by failure of a column at mid to low level, under the combined effects of axial load (gravity and vertical earthquake) and inter-storey displacement. Low concrete strength could have made this scenario more likely.
3. Column failure due to diaphragm (slab) disconnection from the north core at Level 2 or Level 3. In this scenario, the diaphragm separated from the north core causing a significant increase in the inter-storey displacements in the floors above and below. The nature of the separation and resulting movement of the slab would have an influence on which of these highly loaded columns was the most critical. It was noted that no drag bars were installed at these levels.
4. Column failure due to diaphragm (slab) disconnection from the north core at Levels 4, 5 or 6. This scenario has similar characteristics to scenario 3 but involves failure of drag bars and adjacent slab connections to the north core. A compounding factor in this scenario is the effect of uplift of the slab/wall connection due to northwards displacement of the north core.

The effects of diaphragm (slab) disconnection were not modelled but disconnection at any level would lead to increased lateral displacements.

Figure 5.8 outlines the key considerations involved in evaluating these scenarios.

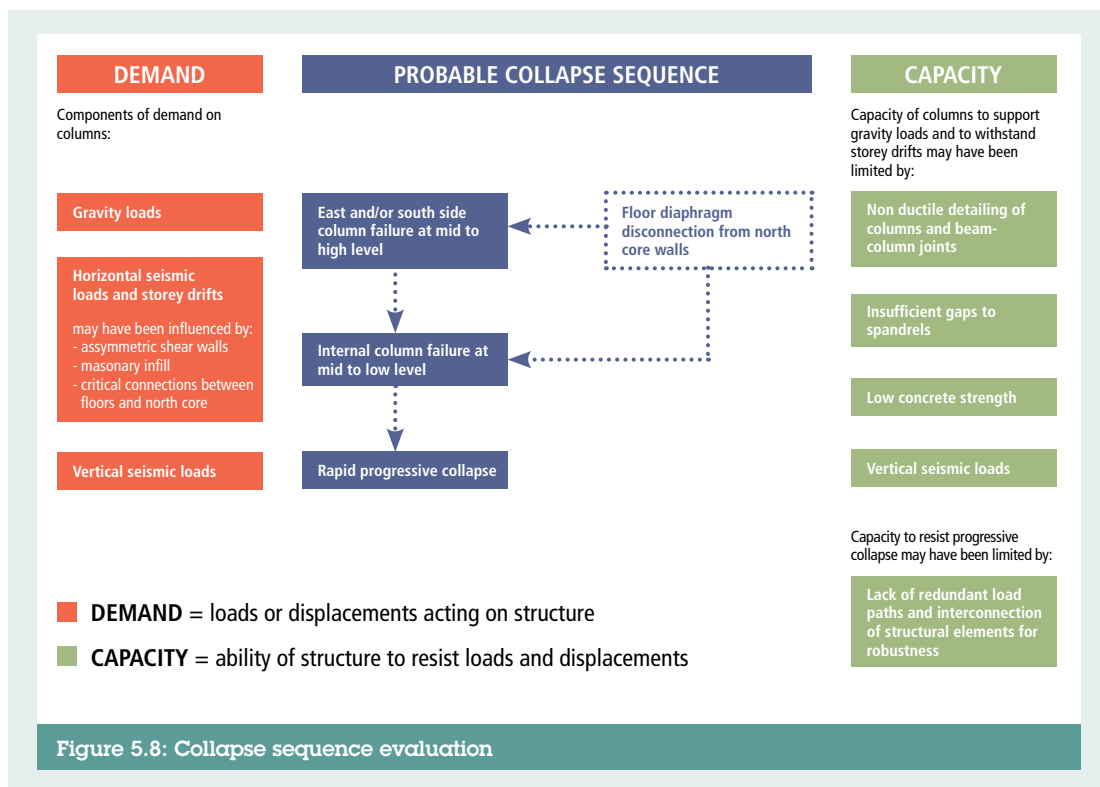

## 5.0 CANTERBURY TELEVISION BUILDING

### Critical column identification

Analyses showed that drift (ie lateral displacements) demands were generally greater at the upper levels of the structure than at lower levels. For drifts in the north-south direction, the Line F (east side) columns were more vulnerable than columns on other lines because they formed a moment frame with the stiff façade beams and they may also have interacted with the spandrel panels. Drift demands in the east-west direction were greater towards the southern side of the building, being more distant from the stiff and strong north core walls. Line 1 (south side) columns also formed a moment frame with the stiff façade beams, and would have been subject to high drift demands in the east-west direction. However, the columns on Line 1 were protected to some extent by the south wall and so were considered to be less vulnerable than the columns on Line F.

The columns on Line 2 were seen as potentially vulnerable. While the lateral displacements (drifts) may have been less than on Line 1, these internal columns supported additional gravity load (with floor slabs all around). They also may have been more vulnerable to vertical acceleration effects due to the higher axial loads carried. Thus it was recognised that the reduced drift demand could have been matched or exceeded by a reduction in capacity to sustain the drifts imposed.

Taking the above factors into account, critical columns were identified on Lines F and 2 by examining the ratio of drift demand to column capacity at various levels. This process resulted in the identification of two "indicator" columns – one at Level 3 at grid position F2 and one at Level 3 at grid position D2. These particular columns were chosen because, based on maximum drifts from the NTHA, and assuming average concrete strengths, the ratio of lateral displacement demand to column capacity would be greatest in these columns.

In making these comparisons, it was recognised that the existence of low concrete strength, vertical acceleration effects, diaphragm separation and/or a different level of interaction with a spandrel panel could mean that a column in another location could have initiated failure.

## 5.10 Key data and results

### Elastic response spectra

Figure 5.9 shows the basic "response spectra" used in the elastic response spectrum analyses. In this graph, the vertical axis represents the expected response of a building to the ground shaking. The horizontal scale shows the natural period of vibration of a building (low buildings generally having low periods and high buildings having high periods). The natural vibration period of the CTV Building was around 1.0 second.

The graphs give an indication of the relative intensities of ground shaking and expected building response on 4 September 2010, 26 December 2010 and 22 February 2011 (solid lines) and the response spectra used for design in 1986 when the CTV Building was designed (dotted lines). The upper dotted line represents full "ultimate" demand level which may be compared with the solid lines derived for the earthquake events.

Although direct comparison of such spectra can be misleading, it can be seen that at a period of 1.0 second, the acceleration shown for the 22 February 2011 event significantly exceeds the full 1984 value required for the design of elastically responding structures, while the acceleration shown for the 4 September 2010 event is around 65 percent of the full 1984 value. The CTV Building had been designed for ductile response using forces derived from the lowest design spectra shown in Figure 5.9.

5.0 CANTERBURY TELEVISION BUILDING

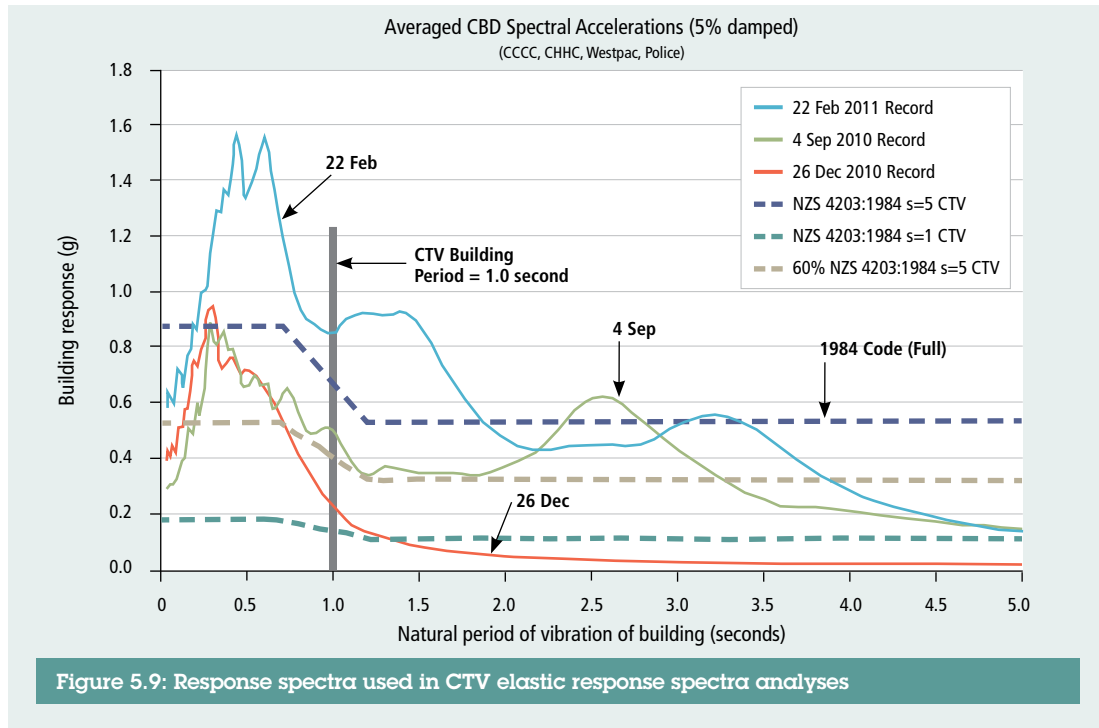

Demand versus capacity

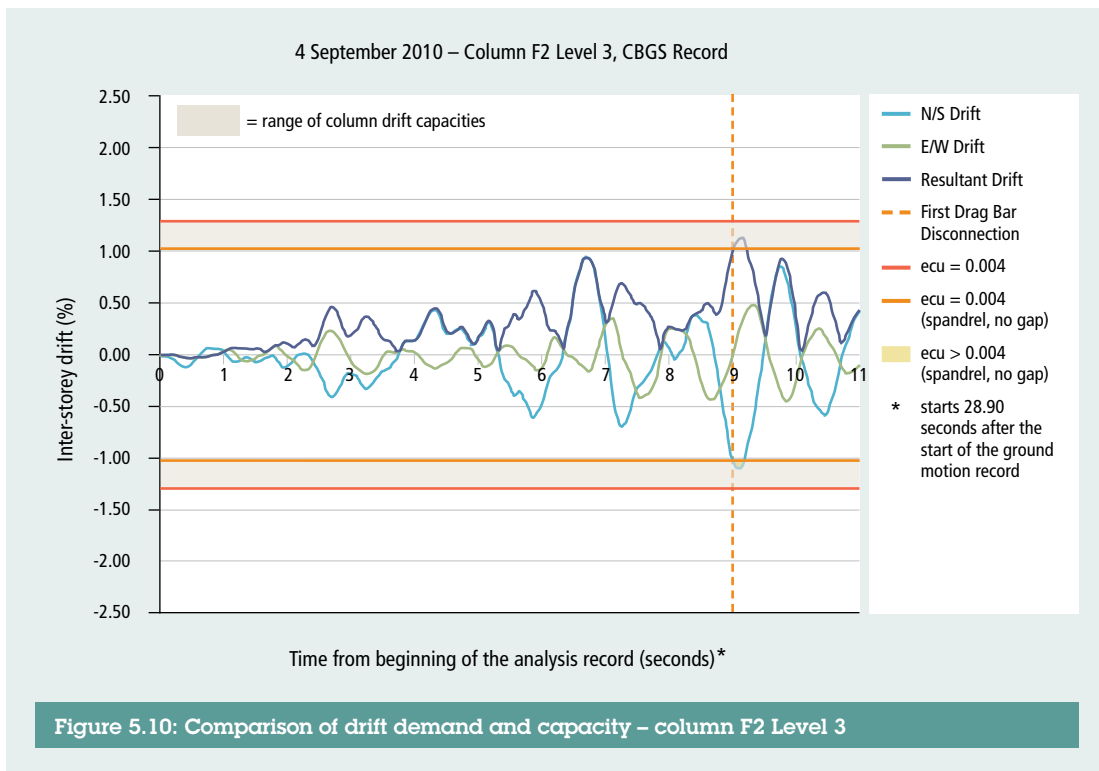

## 5.0 CANTERBURY TELEVISION BUILDING

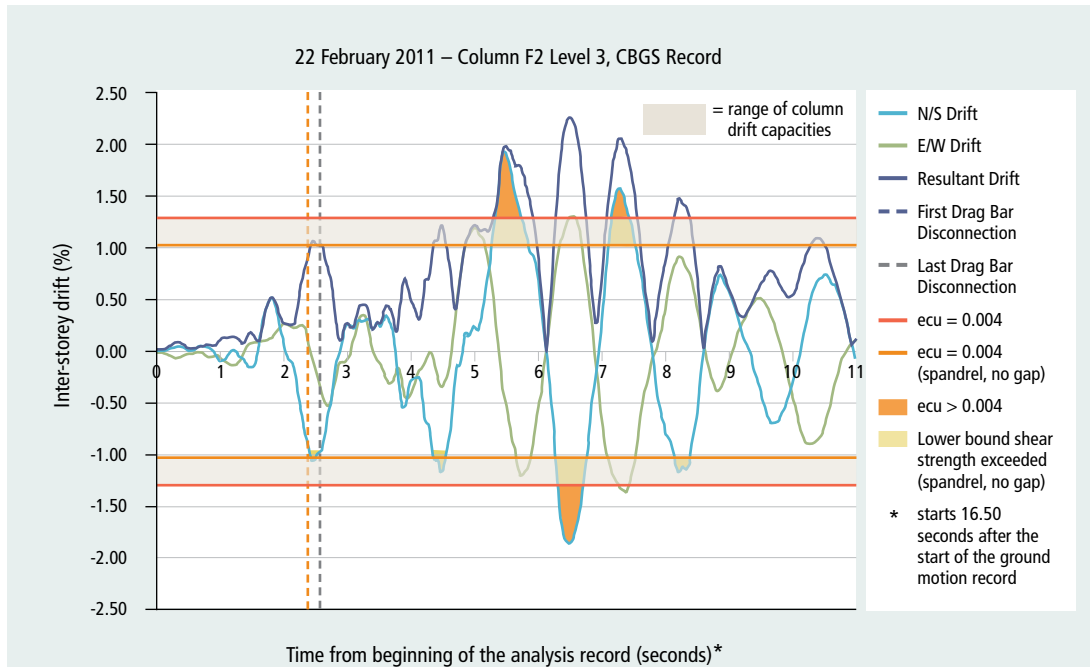

Figure 5.11: Comparison of drift demand and capacity – column F2 Level 3

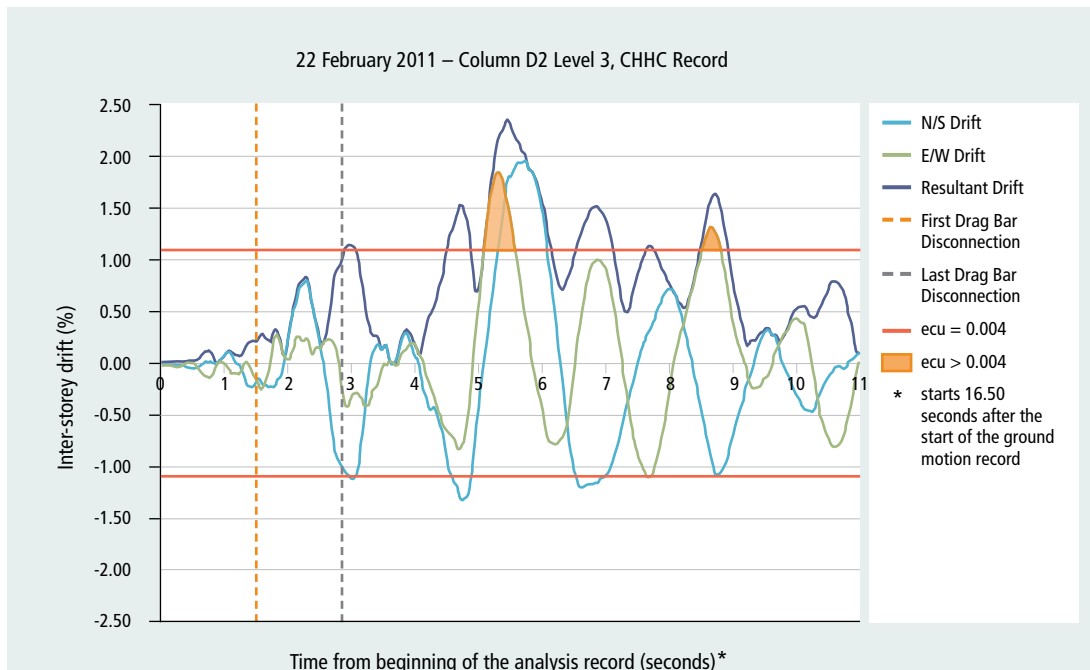

Figure 5.12: Comparison of drift demand and capacity – column D2 Level 3

## 5.0 CANTERBURY TELEVISION BUILDING

Figure 5.10 and Figure 5.11 show output from the non-linear time history analyses for column F2. Figure 5.12 shows output from the analyses for column D2. The vertical axis shows the amount of inter-storey displacement (drift) at this column location. The horizontal axis is the time from start of shaking (as input into the analysis). The wavy lines plot the drift level over time and are based on application of the full ground shaking record in the analyses. This drift is a key measure of demand on the column. The light blue line shows the north-south drift which is critical for the grid F columns, taking into account the stiff façade beams and the potential interaction with spandrel panels. The dark blue line indicates the resultant drift of the north-south and east-west drifts.

Note that the time shown on the horizontal scale in Figure 5.10, Figure 5.11 and Figure 5.12 is the time from the start of the analysis. For the 4 September 2010 case, analysis started at 28.90 seconds from the start of the ground motion record. For the 22 February 2011 cases, analyses started at 16.50 seconds. Thus the maximum response shown on Figure 5.11 at around 5.5 seconds into the analysis corresponds to 22 seconds from start of the ground motion record.

The horizontal lines represent the estimated capacity of this column to sustain the drift without failing according to various criteria (assuming average concrete strength and without vertical earthquake effects). The band between the horizontal lines in Figures 5.10 and 5.11 reflects the difference between “no interaction with the spandrels” (higher value) and “full interaction with the spandrels”. The areas where the drift has exceeded the estimated capacity are shown shaded dark orange. The band showing the range of capacities would be wider if allowance was made for the effect of variable concrete strength and vertical earthquake forces in the column.

Estimates were made of the influence of axial load and concrete strength on the drift capacities of columns in different locations. Three key capacity points were identified for each case: the displacement to cause initial yield in the reinforcing steel, initiation of concrete crushing, and the displacement to cause the ultimate strain in the concrete (at which failure was taken to occur).

An important feature of this analysis was that for heavily loaded columns, the displacement to cause yielding of the main column bars was close to the displacement to cause failure. This is significant because it indicates that significant displacements, such as occurred on 4 September 2010, could be sustained with little evidence of distress, yet collapse could occur due to a relatively small additional displacement.

The key points to note are that, for the 4 September 2010 event, the maximum displacement demands are about half those calculated for the 22 February 2011 event. Although there are two places where the 4 September 2010 displacements are shaded, only one of these is for the north-south drift. There are no cases where they exceed the maximum assessed capacity. On the other hand, the 22 February 2011 demands have many “excursions” shown shaded and three that exceed the maximum value by a noticeable margin.

Similar plots were made for column D2 at Level 3, shown in Figure 5.12, with similar conclusions being reached regarding the likely performance of this column in the 22 February 2011 event.

Such comparisons provide valuable insights into the relativity of demand and capacity, but must be interpreted with care.

These comparisons give some indication of the challenges of determining which column or mechanism initiated failure. However, the plots indicate clearly that there is a strong likelihood that the demands of the 22 February 2011 event were enough to cause column failure, whereas the demands of 4 September 2010 were not.

Although the vertical accelerations at the site could have been high during the 22 February 2011 event, the analyses completed indicated column failure was possible without the additional effects from vertical accelerations.

## 5.0 CANTERBURY TELEVISION BUILDING

Displacements for column D2 on Level 1 (ground floor) (for the full record) were well below the assessed capacity of this column for 4 September 2010 and only marginally exceeded the capacity for the 22 February 2011 analysis. This is a broad indication that this column is less likely to have been the initiator of the collapse. However, this possibility cannot be ruled out because this column may have had lower than average concrete strength and/or suffered more from the effects of the considerable vertical forces generated in the 22 February 2011 event.

The vertical accelerations measured in the 22 February 2011 aftershock were exceptionally high and may have contributed significantly to vertical forces and columns and walls. The extent of this contribution is generally difficult to quantify, but analyses of the CTV Building indicated that vertical accelerations could have doubled the vertical forces in some critical, heavily loaded columns and this may have reduced the capacity of those columns to sustain lateral displacements by up to 40%, depending on concrete strength. If concrete strength in those critical columns had been less than the values that the analyses were based on, the displacement capacity would have been further reduced.

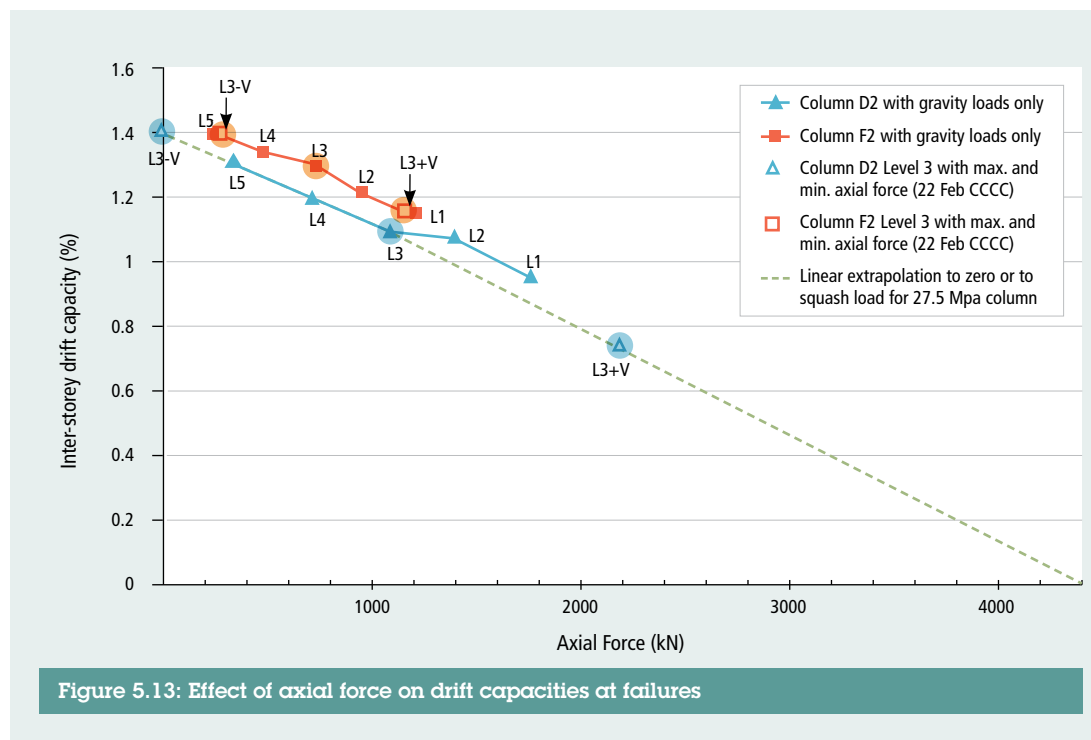

The highlighted markers on each plot in Figure 5.13 show the situation for two columns at Level 3. The middle highlighted marker shows the axial force and drift capacity without earthquake effects. The highlighted markers to the right and left show the effects of vertical earthquakes, reducing (left mark), or increasing (right mark) the column axial force (compression). It can be seen that in these examples, the effect on drift capacity is significant, ranging up to more than 30%.

## 5.0 CANTERBURY TELEVISION BUILDING

### Drift demand capacity comparison

Tables 5.1a and 5.1b show a comparison of calculated drift demands for the CBGS record and capacities for two indicator columns, column F2 at Levels 3 to 4 and column D2 at Levels 3 to 4.

A. Column on grid F2 at Level 3		
Demand or Capacity	Event/Condition	North-South Column drifts (% of floor height)
		Full Record
Demand	22 February 2011 (NTHA – CBGS)	1.9
	26 December 2010 (estimate)	0.5
	4 September 2010 (NTHA – CBGS)	1.0
	1986 Non-ductile detailing	0.6
	1986 Ultimate	1.1
	2010 Ultimate	2.3
Capacity	Failure (No spandrel effect)	1.2 - 1.3 (range)
	Failure (Full spandrel effect)	0.9 - 1.0 (range)

Table 5.1a: Indicative drift demand and capacity values

B. Column on grid D2 at Level 3		
Demand or Capacity	Event/Condition	East-West Column drifts (% of floor height)
		Full Record
Demand	22 February 2011 (NTHA – CHHC)	1.9
	26 December 2010 (estimate)	0.4
	4 September 2010 (estimate)	No analysis
	1986 Non-ductile detailing	0.5
	1986 Ultimate	1.0
	2010 Ultimate	1.8
Capacity	Failure (No spandrel effect)	1.1 - 1.2 (range)
	Failure (Full spandrel effect)	No spandrel

Table 5.1b: Indicative drift demand and capacity values



## 5.0 CANTERBURY TELEVISION BUILDING

Each table shows the maximum drift demand for 4 September 2010, 26 December 2010 and 22 February 2011 for the full record. For the 22 February 2011 event, the range shown represents the maximum drifts found for three separate analyses using records from the CCCC, CHHC and CBGS stations. Also shown are two 1986 standard design limits for the CTV Building:

- The “1986 Non-ductile detailing” figure is the drift demand computed in accordance with 1986 standards to determine the need or otherwise for ductile detailing of the columns. Non-ductile detailing would be allowed provided that the actions induced in the column at this point did not exceed a specified strength limit.
- The “1986 Ultimate” drift is the maximum expected drift demand calculated for the CTV Building indicator columns by the ERSA using the elastic design spectra and standard methods applicable in 1986.

The “2010 Ultimate” drift is also shown to indicate the level of drift demand current design requirements would place on the CTV Building indicator columns. As such it is a measure of the difference between 1986 design requirements and those of current standards – which require all columns, irrespective of drift, to be detailed for at least nominal ductility.

The “Failure” values in the Capacity part of the tables are the estimated drifts at which failure of the column was calculated to occur using average measured properties and without vertical earthquake effects.

### 5.1.1 Possible collapse scenario

Collapse was almost certainly initiated by failure of a circular column when the lateral displacement of the building was more than the column could sustain. Several possible scenarios leading to column failure were identified. Variability and uncertainty in physical properties and the analysis processes do not allow a particular scenario to be determined with confidence. However, the results of the analyses, taken together with the examination of the building remnants, eye-witness accounts and inspection of photos taken after the collapse, point to scenario 1, involving initiation of failure on Line F, as being a strong possibility.

An interpretation of this scenario is that collapse was initiated by the failure of one or more columns on the east face of the building. These columns experienced high drift demands and may have made contact with the pre-cast concrete spandrel panels placed between them, reducing their ability to cope with building displacement. Loss of these columns immediately put large additional gravity loads on the adjacent interior columns which were highly loaded at the lower levels.

The progression of collapse through the building would have been rapid. The columns were relatively small in cross-section and had a low amount of confinement steel. Even if the columns had been more closely confined, loss of cover concrete would have resulted in a substantial increase in compressive stress and extreme demands on the remaining confined section. The columns thus had little capacity to sustain load and absorb greater than anticipated displacement of the building.

Once the interior columns began to collapse, the beams and slabs above fell down and broke away from the north core, and the south wall and the beams and columns attached to it then fell northwards onto the collapsed floors and roof.

## 5.0 CANTERBURY TELEVISION BUILDING

Figure 5.14 shows the situation for this scenario with no spandrel interaction (A) and with spandrel interaction (B and C). Figure 5.16 illustrates the case of failure of ground floor columns on Line D for this scenario and the subsequent collapse of the floor slabs and frames for this inferred collapse sequence. Figure 5.15 shows the case along Line 2 of the scenario involving initiation on Line F.

Concrete strengths that were lower than the average used in the analyses would have reduced the load capacities of critical columns. Vertical accelerations from the ground motions may have added to the demands on columns and reduced their capacities to tolerate lateral displacement. The lack of symmetry of the lateral load-resisting elements is likely to have placed further demands on the critical columns by causing the building to twist and displacements to be larger than expected. Failure of diaphragm connections between floors and the north core walls, if it occurred prior to collapse initiating elsewhere, may have resulted in additional displacement demands on the critical columns.

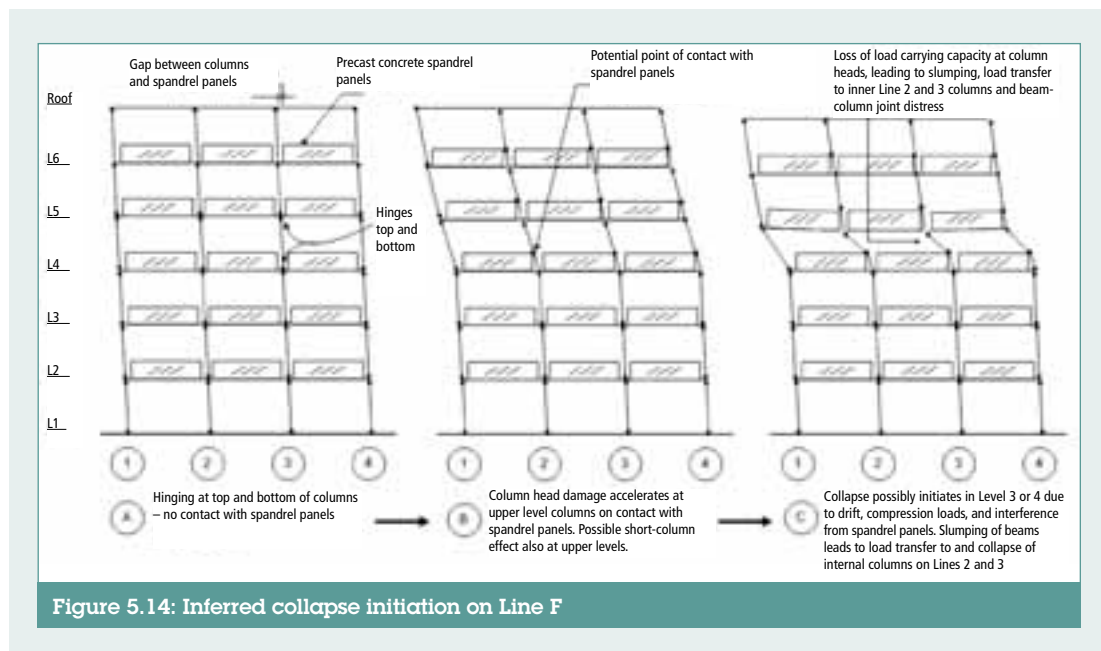

Figure 5.14: Inferred collapse initiation on Line F

## 5.0 CANTERBURY TELEVISION BUILDING

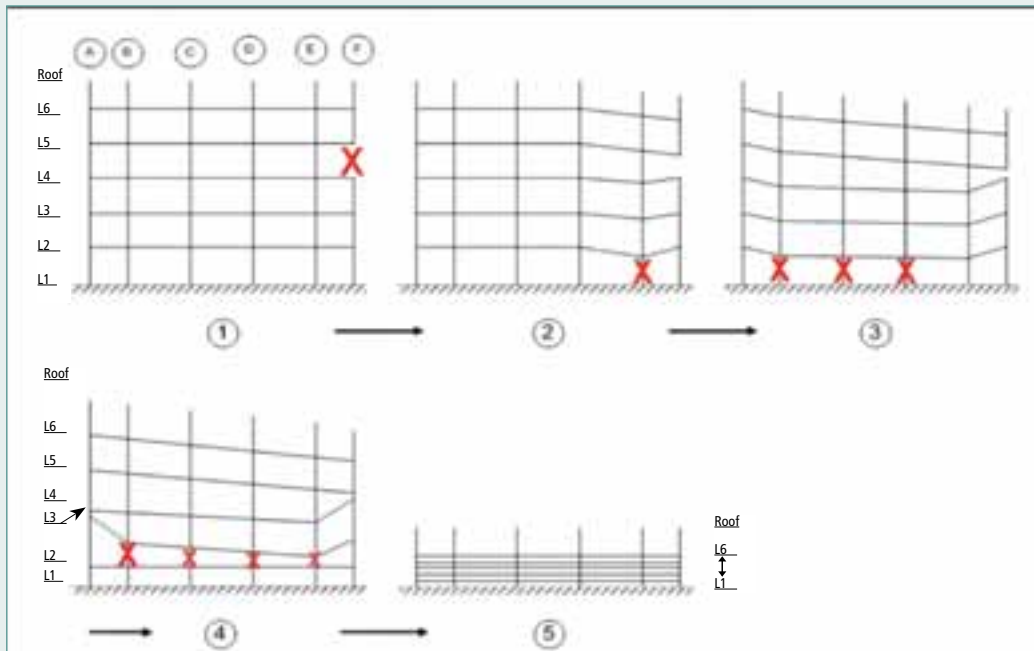

Figure 5.15: Inferred collapse sequence on Line 2

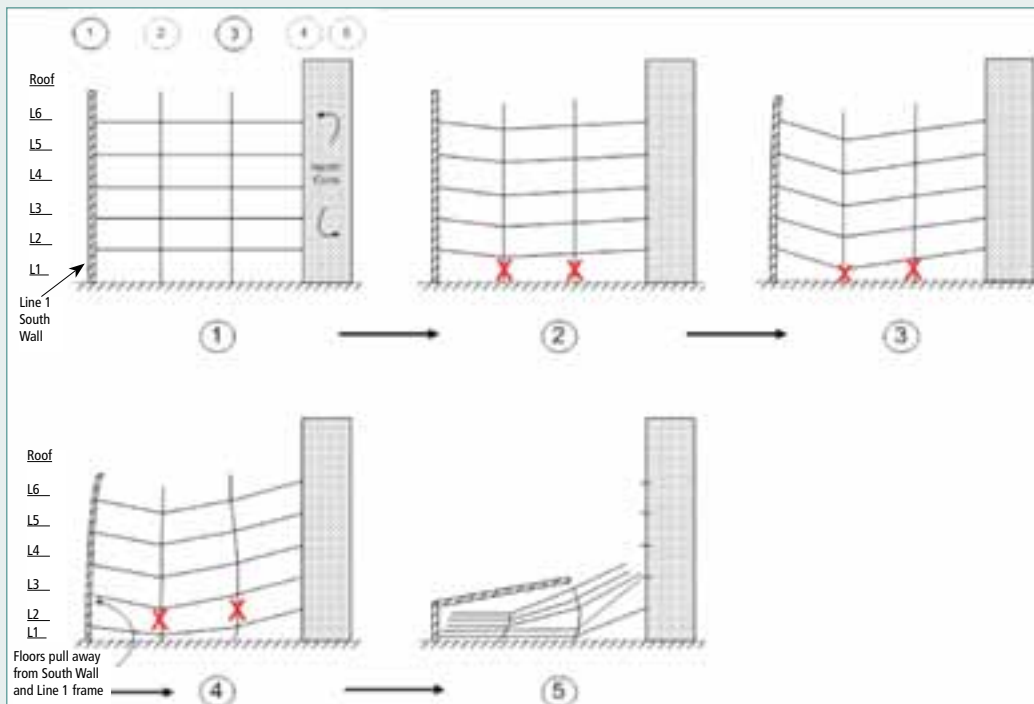

Figure 5.16: Inferred collapse sequence on Line D

## 5.0 CANTERBURY TELEVISION BUILDING

### 5.12 Compliance/standards issues

While it was not a primary objective, the investigation looked at how the CTV Building compared with the design and construction standards of the day. Issues assessed included those where the design, the construction, or the standards of the day as applied to the CTV Building could have been potential contributors to the collapse. These are outlined below:

#### Building inter-storey drift limits

When the building was designed in 1986, the building as a whole was required to have sufficient stiffness to limit the computed inter-storey displacement to below 0.83% of the inter-storey height. The CTV Building as a whole was found to have satisfied this inter-storey drift requirement of the standard.

#### Drift capacity of columns

The beams and columns on Lines 1, 2, 3, 4, A and F were found to have been designed as Group 2 secondary structural elements, not forming part of the primary seismic force resisting system.

The structural design standard applicable at the time of design had a general requirement that all important structural members be detailed to sustain loads at the maximum expected earthquake displacements of the building. The design standard also made a recommendation that all secondary frames be designed for ductility. The concrete design standard applicable at the time of design contained clauses that allowed "secondary" structural members to meet a less stringent ductility requirement. Under this interpretation, adequate performance of the secondary member was required to be demonstrated at 55% of the maximum expected earthquake displacements. For the CTV indicator columns the applicable displacement for this check is the "1986 Non-ductile detailing" figure in Tables 5.1a and 5.1b. The CTV columns should have been detailed for ductility in either case.

In a similar way, because they are an integral part of the columns, the beam-column joints were required to be detailed for ductility.

There needs to be a review of current requirements for ductile detailing of members, particularly those columns which are not regarded as part of the primary lateral load-resisting structure. It is important that design criteria are seen as adequate in the light of the ground shaking experienced in Christchurch and the performance of the CTV and other buildings.

#### Minimum column shear reinforcement

The concrete design standard applicable at the time of design had minimum requirements for shear reinforcement in columns, such as those in the CTV Building. The reinforcement in the CTV columns did not meet these requirements.

#### Spandrel panel separation

The spandrel panels were required to be separated from the columns to allow adequately for seismic movement and construction variations with allowable tolerances. A total gap allowing for seismic drift and construction tolerance of approximately 19mm would have been required unless specific requirements for an absolute minimum gap with tighter tolerance was specified. The drawings showed a nominal 10mm gap with no specific reference to it being a seismic separation gap.

## 5.0 CANTERBURY TELEVISION BUILDING

### Plan asymmetry and vertical irregularity

The main seismic resisting elements (ie the concrete shear walls) were not located symmetrically about the centre of mass as recommended in NZS 4203:1984. The centre of stiffness of the designated primary seismic resisting elements was significantly eccentric to the centre of mass. The two main stabilising elements, the north core and the south wall, had significantly dissimilar stiffness and strength, and were outside recommended design limits for static analysis. However, there were no specific restrictions on geometric irregularity if ERSA was used. Specific warnings remained in the Loadings Standard about the ability to predict the performance of very irregular buildings with greater than moderate eccentricity such as the CTV Building.

### Wall on Line A

From the design calculations it appears that the Line A masonry infill wall was intended to be separated from the structure. The appearance and performance of this wall suggests that it was not separated from the structure.

### Diaphragm connection

No specific reinforcing steel was shown on the structural drawings to connect the north core lift shaft walls into the floor slabs. This omission was picked up after construction during a pre-purchase review for a potential purchaser by an independent consulting engineer and, in October 1991, resulted in the design and subsequent installation of steel angle connectors (drag bars) on Levels 4, 5 and 6.

The retrofitted drag bars were designed according to the requirements of the loadings standard of the day (NZS 4203:1984).

Although this standard had provisions for designing diaphragms and their connections, the provisions were found in the investigation to be insufficient to ensure the diaphragm connection was strong and/or ductile enough for full performance of the north core and south wall. This may be a concern for other buildings relying on floor diaphragm connections to shear walls and designed using the same standard. A review of current standards is needed.

### Documentation

The gap between the spandrel panels and the columns was not identified as a minimum for seismic separation purposes.

It was noted that the top course masonry infill on Line A was shown as fully grouted which would have prevented the desired horizontal slip.

The pre-cast beams on Lines 1 and 4 between lines A and B had no starter bars shown extending into the slab on the drawings. This may have compromised the diaphragm performance in the south-west and north-west corners, and reduced robustness as the collapse developed.

### Percentage New Building Standard assessment

When compared to the current standards for new buildings, the CTV Building would have achieved 40% to 55% NBS (New Building Standard). This figure applies to the pre-September 2010 condition and is based on detailed analyses of column drift demand and capacity carried out as part of this investigation. The lower figure is based on significant spandrel interaction with the columns and the higher figure on no spandrel interaction.

### Geotechnical compliance

The soils investigation report prepared for the design engineer at the time of the design was reviewed by a leading geotechnical consultant as part of this investigation. The consultant considered that the geotechnical investigation carried out in 1986 was typical of the time and appropriate for the expected development.

## 5.0 CANTERBURY TELEVISION BUILDING

### Construction issues

A number of areas were identified where construction issues could have introduced potential weaknesses in the building including the following:

- **Concrete strength** – Tests on 26 columns after the collapse found that the concrete in many columns was significantly weaker than expected. Cores taken from the Line 4-D/E columns were found to have traces of silt.
- **Construction joints** – In many construction joints the concrete surface was not roughened in accordance with the requirements of the concrete construction standard.
- **Bent-up bars** – Some of the beams on the north face of the building were found not to have their reinforcing steel properly connected into the west face of the north core on a number of floors.
- **Separation of elements** – Some of the reinforced masonry infill walls constructed between beams and columns appeared to have been constructed so that the intended structural separation was not fully achieved.

### Construction supervision and monitoring

The investigation highlights the need for buildings to be built in accordance with the drawings and specification, and the need to have confidence that the design intent also has been interpreted correctly and followed through. Effective quality assurance measures need to be developed and implemented during construction. This includes having appropriately trained and qualified personnel undertaking the work, adequate supervision, approvals and audit by the consenting authority, and construction monitoring by the design engineer and architect.

## 5.13 Conclusions

The investigation found that there was no evidence to indicate that the damage to the structure observed and/or reported after the 4 September 2010 earthquake and the 26 December 2010 aftershock caused significant weakening of the structure with respect to the mode of collapse on 22 February 2011.

Although there is some scope for interpretation of the reported building condition, the estimated response of the building using the 4 September 2010 ground shaking records and the assessed effects on critical elements are not inconsistent with observations following the 4 September 2010 event. Analyses using the full 22 February 2011 aftershock ground motion records indicate displacement demands on critical elements to be in excess of their capacities even assuming no spandrel interaction and no vertical earthquake accelerations.

The following factors were identified as likely or possible contributors to the collapse of the CTV Building:

- The stronger than design-level ground shaking.
- The low displacement-drift capacity of the columns due to:
  - the low amounts of spiral reinforcing in the columns which resulted in sudden failure once concrete strain limits were reached
  - the large proportion of cover concrete, which would have substantially reduced the capacity of columns after crushing and spalling
  - significantly lower than expected concrete strength in some of the critical columns
  - the effects of vertical earthquake accelerations, probably increasing the axial load demand on the columns and reducing their capacity to sustain drift.
  - loss of diaphragm connection to the north core at Lines D and E.

## 5.0 CANTERBURY TELEVISION BUILDING

- The lack of sufficient separation between the perimeter columns and the spandrel panels which may have reduced the capacity of the columns to sustain the lateral building displacements.
- The plan irregularity of the earthquake-resisting elements which further increased the inter-storey drifts on the east and south faces.
- Increased displacement demands due to diaphragm (slab) separation from the north core.
- The plan and vertical irregularity produced by the influence of the masonry walls on the west face up to Level 4 which further amplified the torsional response and displacement demand.
- The limited robustness (tying together of the building) and redundancy (alternative load path) which meant that the collapse was rapid and extensive.

Surveys of the site after the collapse indicated that there had been no significant vertical or horizontal movement of the foundations. There was no evidence of liquefaction.

### 5.14 Recommendations

The performance of the CTV Building during the 22 February 2011 aftershock has highlighted the potential vulnerability in large earthquakes of the following:

- **Irregular structures**  
Geometrically irregular structures may not perform as well as structural analyses indicate. There is a need to review the way in which structural irregularities are dealt with in design standards and methods.
- **Non-ductile columns**  
Buildings designed before NZS 3101: 1995, and especially those designed prior to NZS 4203: 1992 (which increased the design drift demand), with non-ductile gravity columns may be unacceptably vulnerable. They should be checked and a retrospective retrofit programme considered.
- **Pre-cast concrete panels**  
Existing buildings with part-height pre-cast concrete panels (or similar elements) between columns may be at risk if separation gaps are not sufficient. Such buildings should be identified and remedial action taken.
- **Diaphragm connections**  
Buildings with connections between floor slabs and shear walls (diaphragm connections) designed to the provisions of Loadings Standard NZ 4203 prior to 1992 may be at risk. Further investigation into the design of connections between floor slabs and structural walls is needed.
- **Design and construction quality**  
There is a need for improved confidence in design and construction quality. Measures need to be implemented which achieve this. Design Features Reports should be introduced and made mandatory. Designers must have an appropriate level of involvement in construction monitoring. There should be a focus on concrete mix designs, in-situ concrete test strengths, construction joint preparation and seismic gap achievement.

It is recommended that the Department take action to address these concerns as a matter of priority and importance. The first four recommendations identify characteristics that, individually and collectively, could have a serious effect on the structural performance of a significant number of existing buildings. It is suggested that these issues be addressed collectively rather than individually.

The Panel recommends that the Department leads a review of the issues raised around design and construction quality. The Department should work with industry to develop and implement changes to relevant legislation, regulations, standards and practices to effect necessary improvements.

6.0

# Pyne Gould Corporation Building

## 6.1 Summary

The five-storey Pyne Gould Corporation (PGC) Building located at 231-233 Cambridge Terrace, Christchurch, suffered a major structural collapse on 22 February 2011 following the Magnitude 6.3 aftershock.

The building collapsed when the reinforced concrete walls of the core of the structure between Level 1 and Level 2 failed. Subsequently, the perimeter columns and/or joints between the columns and the beams and the connections between the floor slabs and the shear-core failed, causing the floors to collapse.

The structure met the 1963 design requirements of that time for the prescribed earthquake loads, both in terms of level of strength and the level of detailing provided.

The principal reasons that the PGC Building collapsed in response to the 22 February 2011 aftershock event were identified as being:

- that the intensity and characteristics of the ground shaking caused forces in the core wall of the building (between Level 1 and Level 2) that exceeded its capacity; and
- that the non-ductile design of the structure, typical of buildings designed in the early 1960s, lacked resilience once the building's strength had been exceeded and was unable to accommodate the shaking associated with the 22 February 2011 aftershock event.

## 6.2 Investigation

A technical investigation into the reasons for the collapse was commissioned by the Department of Building and Housing and this was undertaken by engineering consultants Beca Carter Hollings and Ferner Ltd (Beca).



**6.0** PYNE GOULD CORPORATION BUILDING

**Figure 6.1: PGC Building prior to collapse** (source: S. Tasligedik)

## 6.0 PYNE GOULD CORPORATION BUILDING

### 6.3 Building description

The five-storey office building, designed in 1963, was founded on shallow pads, and its lateral resilience was provided by walls surrounding the stairs and lifts. These walls formed a core, and were approximately symmetrically located about the north-south centre line of the building, but offset from the east-west axis. The axes of the rectangular building were orientated approximately north-south and east-west. These core walls had openings in some areas.

The perimeter of the building above Level 1 was supported on reinforced concrete columns. These were supported on beams which were cantilevered beyond the ground floor reinforced concrete columns. Refer to Figure 6.2.

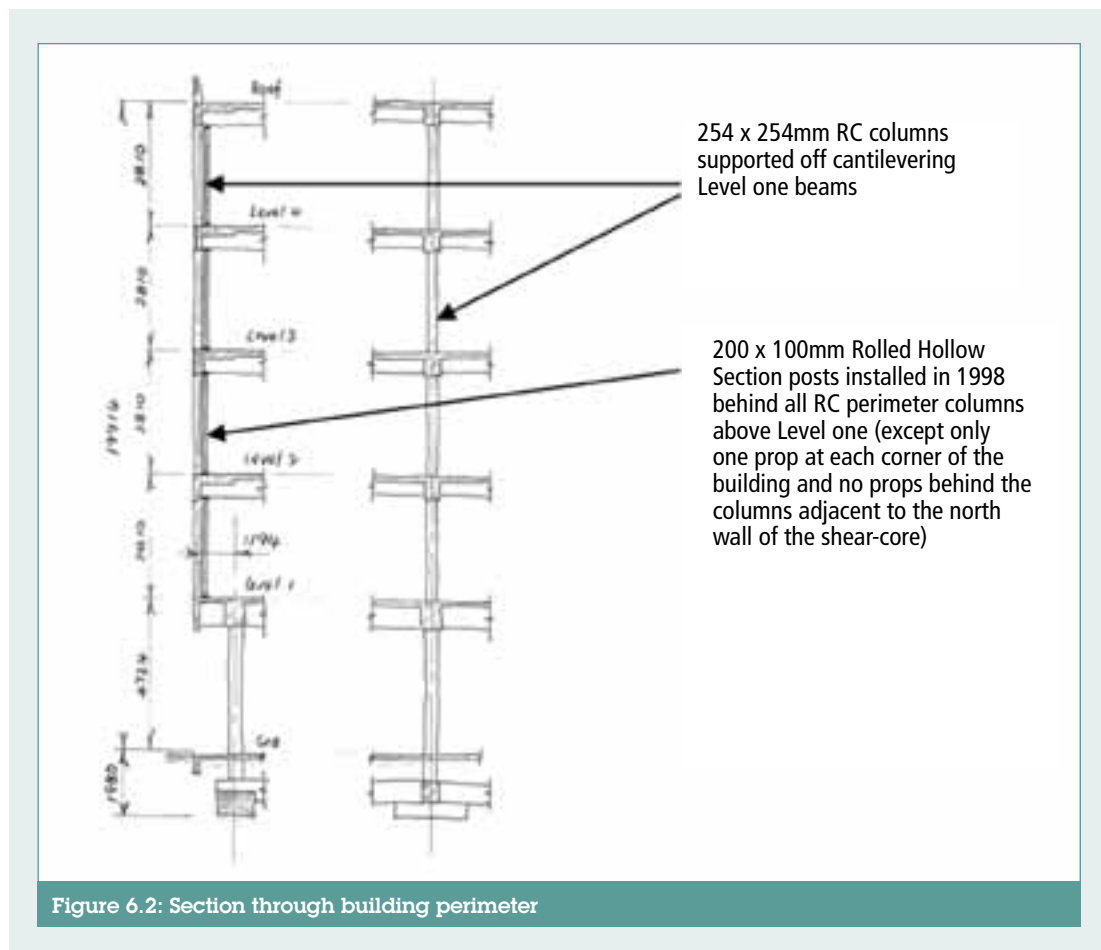

A feature of the building, that affected the way in which it responded to the 22 February 2011 aftershock, was that the structure between Ground Level and Level 1 was significantly stronger and stiffer than immediately above Level 1. Refer to Figures 6.3 and 6.4.

## 6.0 PYNE GOULD CORPORATION BUILDING

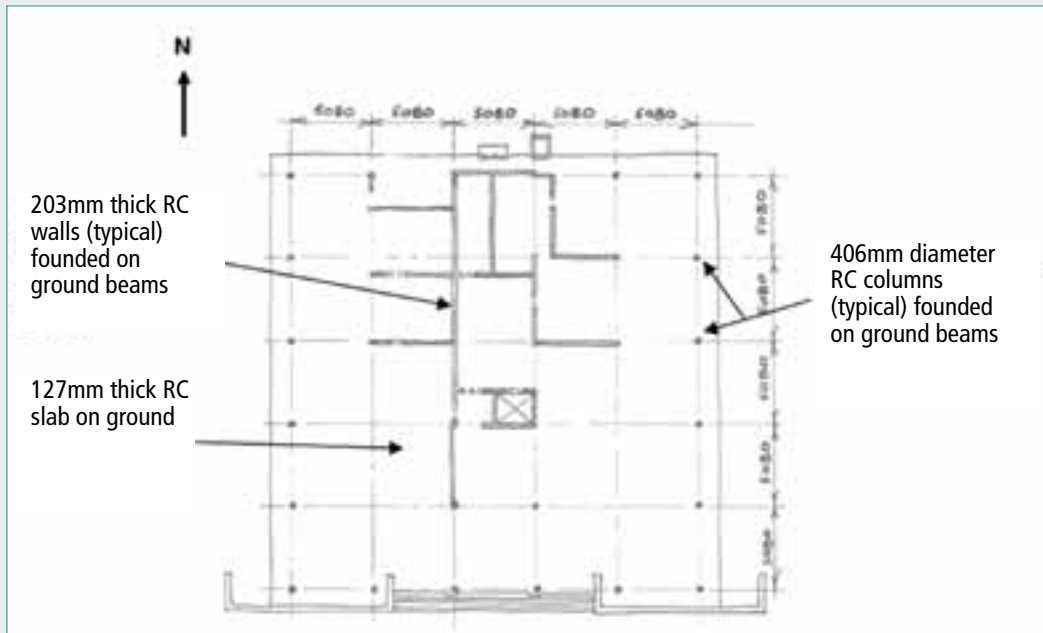

Figure 6.3: Ground Level plan of building

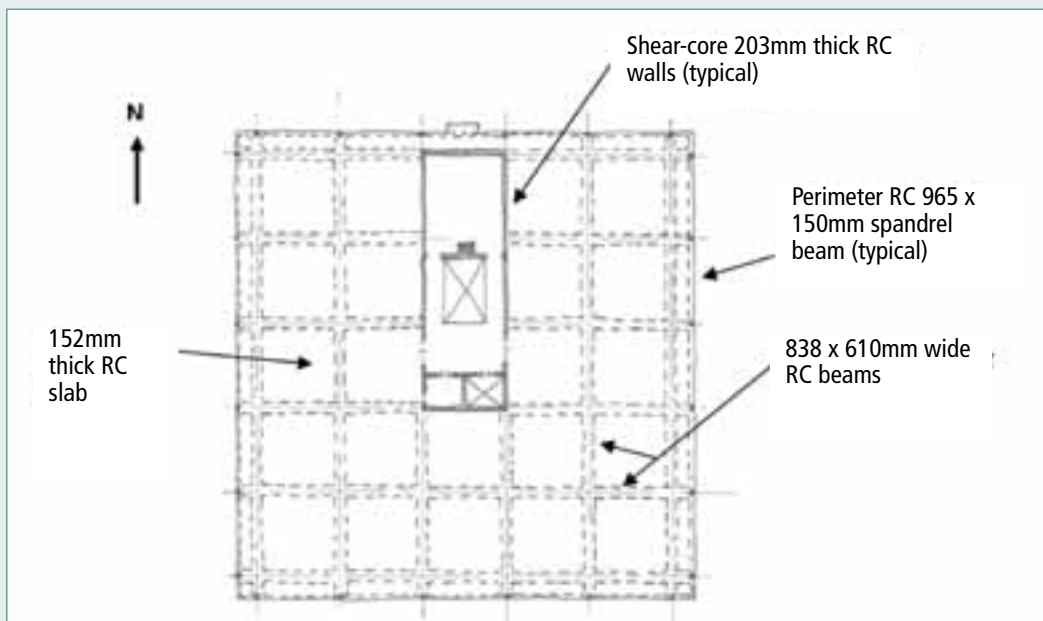

Figure 6.4: Level one plan of building

## 6.0 PYNE GOULD CORPORATION BUILDING

### 6.4 Structural modifications

During a 1998 major refurbishment, steel props were added to the perimeter reinforced concrete columns to enhance their vertical load-carrying capacity. Some investigations were undertaken into providing additional horizontal load resilience via steel bracing, but no additional horizontal resilience was added. Some openings in the concrete walls were in-filled and others created. At the same time as this refurbishment, decorative reinforced concrete umbrella structures on the roof were taken down because they were considered seismically unsafe.

In 2008, a 12 metre steel telecommunications mast was added to the central core walls above the roof level.

### 6.5 Design basis and code compliance

Calculations carried out as part of this investigation confirm that the core walls were reinforced to meet the seismic design loadings current in 1963.

A significant assessment of the building's earthquake resilience was undertaken for the owner in 1997. This identified shortfalls in resilience with respect to the loadings standard current at that time (NZS 4203: 1992).

The capacity of the building after the addition of steel props behind the perimeter columns in 1998 was judged, by the owner's engineer (at that time) to be in excess of 50% of the then current new building standard.

### 6.6 Geotechnical

Soils investigations, additional to those for neighbouring sites for other building developments over the life of the building, have been undertaken at the site and at the nearest earthquake-recording site (Christchurch Resthaven REHS, 670 metres to the north north-west).

Post-earthquake soils investigations gave no indication of deformation of the foundation and/or the site that would be instrumental in the collapse of the structure.

### 6.7 Seismological

The strong-motion recordings obtained from the nearest site (REHS) are considered relevant to the investigation of the building's performance and were used in the analyses. Although the ground conditions at the REHS recording site differ from those at the building site in some respects, they are considered to be the most appropriate to the PGC site.

## 6.8 Effects of 4 September 2010 earthquake and 26 December 2010 aftershock

Minor structural and some non-structural damage was observed as a result of the 4 September 2010 earthquake. Some cracking was observed to the shear-core walls between Levels 1 and 2, to the stair flights, and to the extremities of some perimeter columns.

Eye-witnesses have advised of damage observed after the 4 September 2010 earthquake. Some of this, but not all, has been correlated with known spalling from reinforcing bar corrosion and recorded damage.

After the 26 December 2010 Magnitude 4.9 aftershock, no significant additional damage was recorded.

The owner's structural engineers inspected the building after both the 4 September 2010 earthquake and the 26 December 2010 aftershock, and advised the owner it was acceptable to occupy it.

The extent and location of the damage observed/reported from the 4 September 2010 earthquake and the 26 December 2010 aftershock did not provide signs that the building had been significantly distressed in the shaking that had occurred, or of the collapse that was to occur.

## 6.9 Effects of 22 February 2011 event

The PGC Building collapse appears to have been initiated by the failure in compression of the eastern core wall between Levels 1 and 2. Almost no structural damage was observed between Ground Level and Level 1. The core walls above Level 2 were reportedly largely undamaged. The east half of the roof detached itself from the core and slid partly off the level below on to the adjacent building.

## 6.10 Probable reasons for collapse

Analytical models of the total structure and of the core walls alone have been created. Non-linear time-history analyses using actual records of the three events (4 September 2010, 26 December 2010 and 22 February 2011) recorded 670m from the building have been undertaken.

Analyses confirm that the core wall between Level 1 and Level 2 had insufficient capacity, by a considerable margin, to resist the intensity and characteristics of the ground shaking recorded at the nearest instrument on 22 February 2011.

## 6.11 Conclusions

The PGC Building structure was in accordance with the design requirements of the time (1963), both in terms of the level of strength and the level of detailing provided.

Modifications made to structural elements (addition of perimeter steel props and insertion/deletion of doorways in the core walls) during the life of the building were not material with respect to the collapse on 22 February 2011.

When compared to the current code for new buildings (NZS 1170.5: 2004, NZS 3010: 2006), the PGC Building would have achieved between 30 and 40%NBS (New Building Standard) prior to September 2010, when assessed against the New Zealand Society for Earthquake Engineering Guideline recommendations (NZSEE, 2006).

## 6.0 PYNE GOULD CORPORATION BUILDING

Testing of concrete and reinforcing steel elements retrieved from the collapsed building indicated that the strength and characteristics of those elements were consistent with those specified at the time of design.

The damage to the building as a result of the 4 September 2010 earthquake and the 26 December 2010 aftershock was relatively minor, and was not indicative of a building under immediate distress or having a significantly impaired resistance to earthquake shaking. The proposed method of repair at that time, of grouting the cracks, appears reasonable.

The investigation concluded that the damage observed and/or reported after the 4 September 2010 earthquake and the 26 December 2010 aftershock did not significantly weaken the structure with respect to the mode of collapse on 22 February 2011.

Analyses and site observations indicate the following sequence of collapse (refer to Figure 6.5). The PGC Building collapsed when the east and west reinforced concrete walls of the core between Level 1 and Level 2 failed during the aftershock. The west wall yielded in vertical tension, and then the east wall failed catastrophically in vertical compression. The ground floor structure stayed intact, virtually undamaged as it was significantly stronger and stiffer than the structure above. Torsional response (ie twisting of the building about a vertical axis) was not a significant factor. Once the west wall had failed, the horizontal deflections to the east increased markedly. The perimeter columns and/or joints between the columns and the beams, and the connections between the floor slabs and the shear-core failed consequentially at some levels, causing the floors to collapse.

## 6.0 PYNE GOULD CORPORATION BUILDING

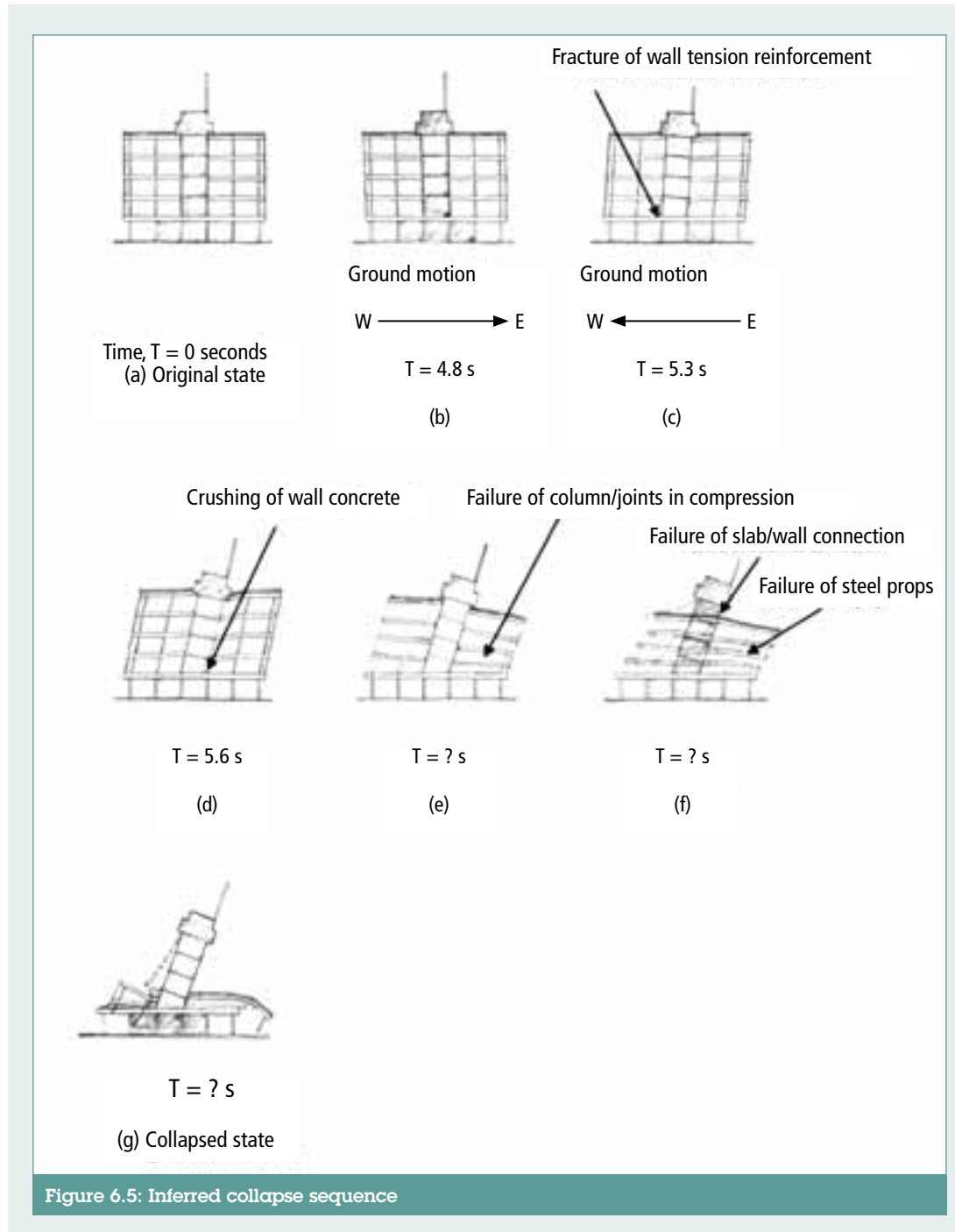

The reason the PGC Building collapsed was that the shaking experienced in the east-west direction was almost certainly several times more intense than the capacity of the structure to resist it. In addition, the connections between the floors and the shear-core, and between the perimeter beams and columns, were not designed to take the distortions associated with the core collapse. Neither foundation instability nor liquefaction was found to be a factor in the collapse.

Extensive studies undertaken in 1997 for a previous owner confirmed that the structure was below the current standard at that time with respect to earthquake resilience for new buildings.

## 6.12 Recommendations

Following the investigation of the PGC Building and subsequent discussions with the Panel, a number of issues have arisen that the Department should give consideration to:

- **Active approach to screening buildings for critical structural weaknesses**  
The benefits of an active approach to the screening of existing buildings for critical structural weaknesses has been highlighted. Territorial authorities should be encouraged to include such an approach in their earthquake-prone building policies.
- **Shear walls**  
The performance of the PGC Building during the 22 February 2011 aftershock has highlighted the potential vulnerability in large earthquakes of lightly, centrally reinforced shear walls without concrete confinement, especially where the horizontal resistance to earthquake is provided solely by the shear wall. Further investigation of the potential seismic performance of existing lightly reinforced shear walls should be a priority.
- **Building assessment guidelines**  
The existing New Zealand Society for Earthquake Engineering building assessment guidelines should be reviewed so that buildings of the PGC Building type are identified as potentially poorly-performing in earthquakes.



## 7.0

# Hotel Grand Chancellor Building

## 7.1 Summary

The Hotel Grand Chancellor complex located at 161 Cashel Street, Christchurch, suffered major structural damage following the Magnitude 6.3 aftershock on 22 February 2011. The extent of damage suffered by the building was significantly increased by the collapse of a key supporting shear wall which failed in a brittle manner.

Extremely high compression loads combined with low levels of confinement reinforcing led to the wall failure. The lapping of vertical reinforcing and the slenderness of the wall also appear to have contributed to the onset of failure. Under the action of high compression loads, a small transverse displacement was enough to initiate failure in unconfined concrete. The high axial loads arose from the building geometry and induced actions resulting from the severe horizontal accelerations. It is highly likely that vertical earthquake accelerations also contributed to the high compression loads.

The building deformations that resulted from the wall failure were sufficient to initiate a major stair collapse within the building and failures to columns and beams at various locations.

## 7.2 Investigation

A technical investigation into the reasons for the structural damage to the Hotel Grand Chancellor Building was commissioned by the Department of Building and Housing and this was undertaken by structural consulting engineers Dunning Thornton Consultants Ltd.

## 7.0 HOTEL GRAND CHANCELLOR BUILDING



Figure 7.1: Hotel Grand Chancellor Building pre-September 2010 earthquake (source: C Lund & Son Ltd website)

### 7.3 Building description

The Hotel Grand Chancellor Building was built between 1985 and 1988 as a hotel with conference facilities.

The complex comprises a 22-storey reinforced concrete tower with an 8-storey interconnected podium on the south side. The upper 15 levels contain hotel accommodation while below that are 6 levels of car parking, split into 12 half-floors. The hotel lobby is located at the ground floor making a total of 28 levels. An adjacent car parking building, though structurally separate, shares the vehicle access ramps with the hotel.

## 7.0 HOTEL GRAND CHANCELLOR BUILDING

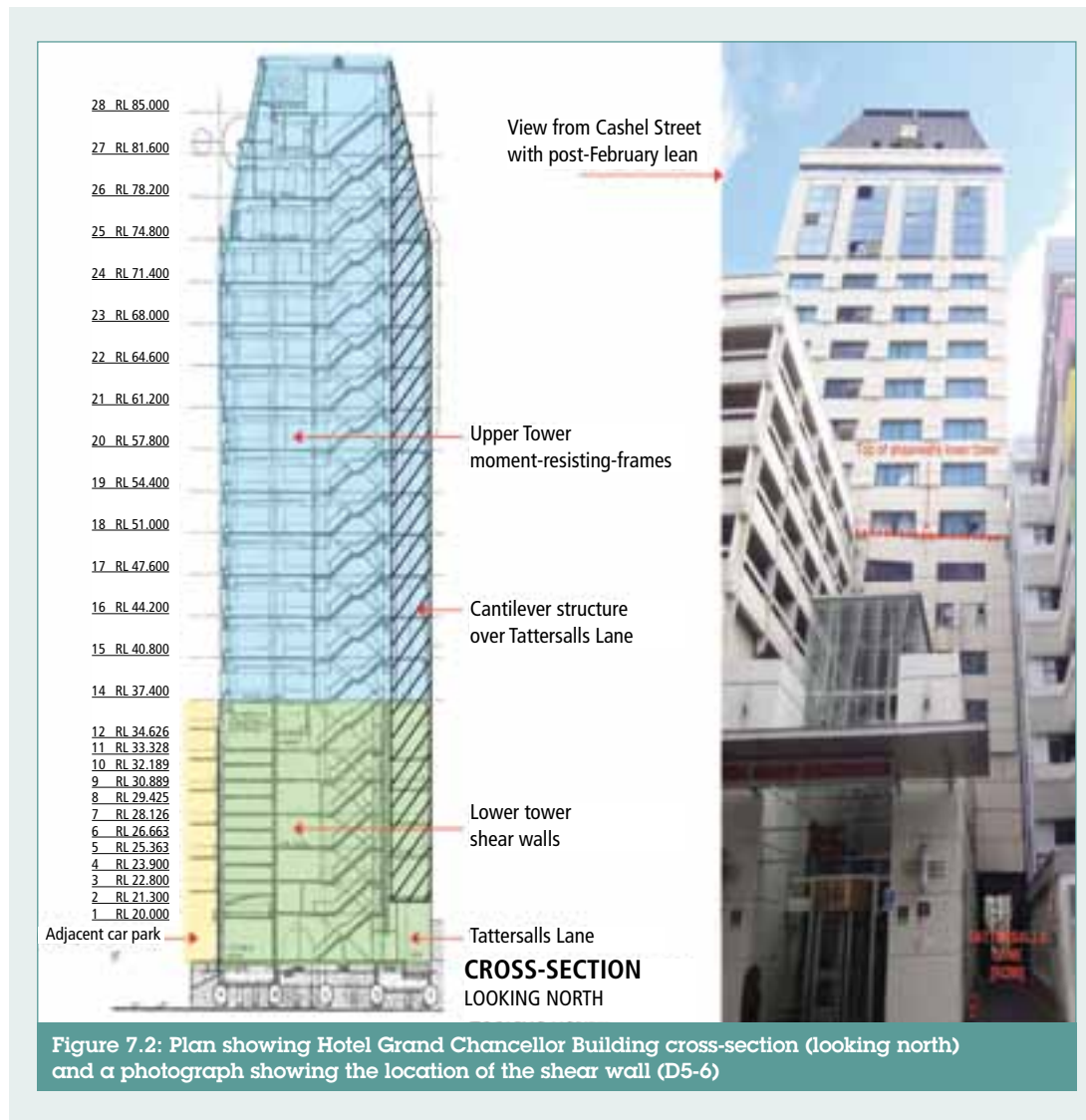

The Hotel Grand Chancellor Building structure has both vertical and horizontal structural irregularity. Vertical irregularity arises from the fact that the upper tower relies on frame action (moment-resisting reinforced concrete frames) for its seismic resistance while the lower tower relies on reinforced concrete shear walls. The two structural forms inherently have different stiffnesses and, if not linked, would respond differently to seismic shaking. The horizontal irregularity arises from the fact that the eastern bay of the building is cantilevered. Large cantilever transfer beams extend out to the east at Levels 12 to 14 above Tattersalls Lane to support the car park floors. Two of these cantilevered transfer beams sit on top of the key supporting shear wall (wall D5-6).

## 7.0 HOTEL GRAND CHANCELLOR BUILDING

### 7.4 Structural modifications

At the ground floor of the complex a right-of-way exists along the east boundary of the site, occupied by Tattersalls Lane. Initial designs for the complex had involved foundations, columns and walls being constructed along (and within) this right-of-way. Construction of the building was reasonably well advanced before legal action effectively prevented construction of any structure within the right-of-way. This change required a structural redesign of the building.

The investigation did not find any evidence of significant structural alterations following the completion of the building.

### 7.5 Design basis and code compliance

The investigation found that, for the most part, the structural design appeared to be compliant with the codes and standards that were applicable when the structure was designed. However, for the failed wall D5-6, it does appear that there were some design assumptions that may have contributed to the failure. The design appears to have underestimated the magnitude of possible axial loads, and the wall lacked the confining reinforcing needed to provide the ductility required to withstand the extreme actions that resulted from the 22 February 2011 aftershock. The assessed response of the building to this shaking exceeded the actions stipulated by both the current and contemporary loadings codes for a building of this type, structural period (of vibration) and importance.

### 7.6 Geotechnical

Geotechnical investigations carried out at the time of the design of the building indicated a soil profile of sandy silts, silty clays and some fine sand overlying gravel at approximately 6m below ground level. Piles for the building were detailed at 500mm diameter and were required to be driven to found firmly in gravels.

There have been no significant surface signs of liquefaction in the vicinity of the Hotel Grand Chancellor site, and geotechnical advice is that the surrounding area had been not been subject to slumping or localised displacement.

While the underlying soil will have had an effect on the building's response to the 22 February 2011 aftershock, the investigation has concluded that there is no evidence of significant foundation failure.

### 7.7 Seismological

Earthquake ground motions were recorded at locations around the Christchurch CBD during the 4 September 2010 earthquake and subsequent aftershocks. These records were translated into both acceleration spectra and displacement spectra. Acceleration spectra show the response accelerations of a building structure compared to its natural period (of vibration). Displacement spectra show the expected displacement of the centre of mass of the structure in relation to its natural period of vibration.

For analysis of the Hotel Grand Chancellor site, only the principal direction of motion at each recording station location was used (the ground motion is normally recorded in two orthogonal directions, and one vertical), and average values were used to determine the response of the structure.

## 7.0 HOTEL GRAND CHANCELLOR BUILDING

### 7.8 Effects of 4 September 2010 earthquake and 26 December 2010 aftershock

The building survived the 4 September 2010 earthquake and the 26 December 2010 aftershock without apparent significant structural damage and was fully in use when the 22 February 2011 event occurred.

### 7.9 Effects of 22 February 2011 event

During the approximate 12 seconds of intense shaking that occurred in the 22 February 2011 aftershock, the Hotel Grand Chancellor Building suffered a major structural failure with the brittle rupture of a shear wall (D5-6, refer to Figure 7.3) in the south-east corner of the building. This shear wall provided vertical support for approximately one-eighth of the building's mass and was also expected to carry a portion of lateral earthquake loads. Damage to the base of the shear wall is shown in the photograph in Figure 7.4.

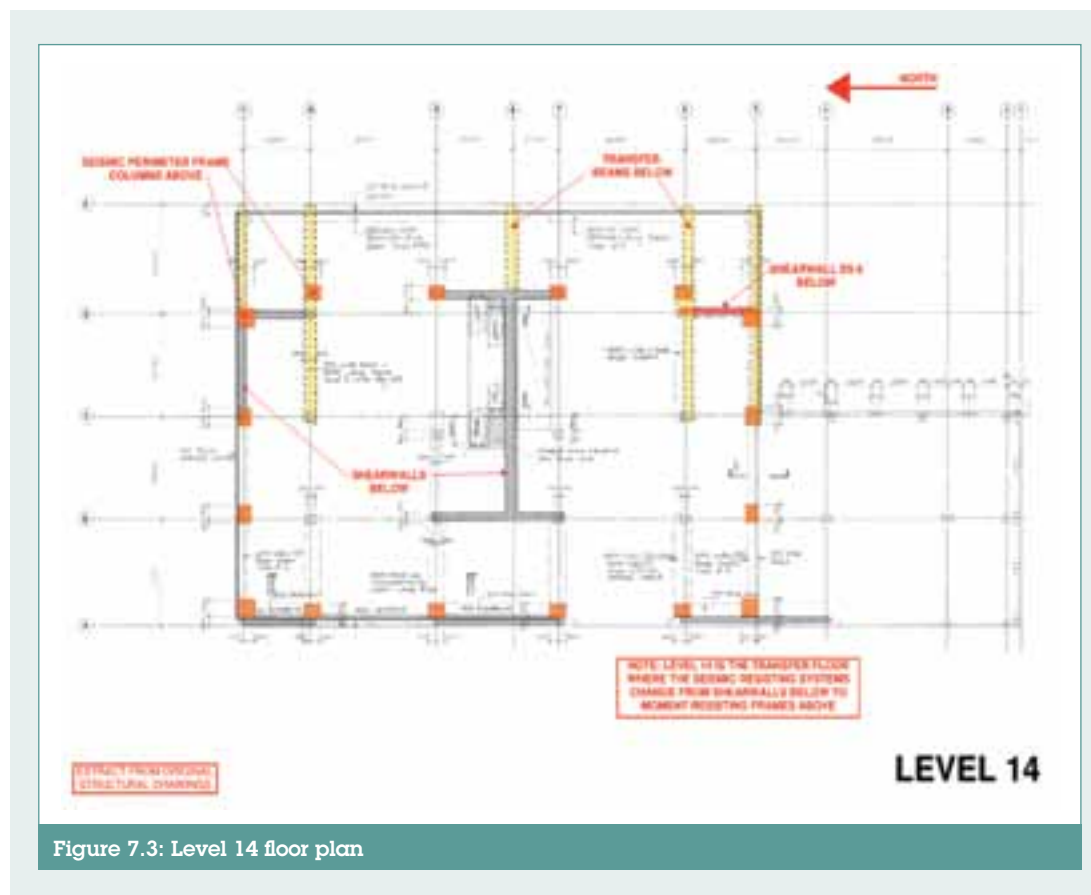

Figure 7.3: Level 14 floor plan

## 7.0 HOTEL GRAND CHANCELLOR BUILDING



Figure 7.4: Shear wall D5-6 base failure (in the hotel foyer)

As a result of the wall failure, the south-east corner of the building dropped by approximately 800mm and developed an accompanying horizontal lean of approximately 1300mm at the top of the building. This major movement induced other damage including column failure at the underside of the podium, beam yielding, stair collapse and pre-cast panel dislodgement. The collapse of the stairs, in particular, was dependent on the wall failure. Other more minor structural damage was consistent with what may have been expected in a well-performing reinforced concrete structure in a seismic event of this nature.

The 22 February 2011 aftershock induced actions within the wall that exceeded its capacity and caused failure and partial collapse.

There was sufficient redundancy and resilience within the overall structure to redistribute the loads from the failing element and halt the collapse.

## 7.10 Probable reasons for structural failure

Analysis suggests that the shaking of the 22 February 2011 event exceeded that stipulated by the code for a building of this type and importance in a 500-year event (New Zealand design standards stipulate a return period of 500 years for the seismic hazard relating to typical use buildings).

Observation and analysis suggests that high compression loads, combined with the low levels of concrete confinement, led to the failure. Wall slenderness and the lapping of vertical secondary (web) reinforcing may have contributed to the onset of failure. When subject to high compressive stresses, unconfined concrete is prone to brittle crushing failure. In this case, extremely high loads, together with some transverse displacement, were sufficient to initiate the concrete failure. The length of the confined zone at each end of the wall was very short and it is probable that the failure initiated behind the confined area, where the longitudinal reinforcing was lapped and unconfined.

### Shear wall failure

The investigation concludes that the following factors contributed to the failure of the critical shear wall (wall D5-6) in the foyer:

- Larger than expected ground accelerations.
- Larger than expected acceleration and displacement demand to the building.
- Higher axial loads than allowed for in the design.
- The probable coincidence of high vertical accelerations with strong horizontal actions.
- The lack of robustness and resilience of the wall and its inability to sustain loads in excess of those allowed for in the design.

Factors and features that contributed to a critical vulnerability within the building included the following:

- Horizontal irregularity of the building arising from the cantilevering of the building over Tattersalls Lane resulting in a disproportionate contributing area being supported by the wall D5-6.
- Vertical irregularity from a framed structure on top of a shear wall podium with transfer beams at the interface.
- Extremely high axial (vertical) wall actions arising from a combination of:
  - gravity (dead plus imposed) loads
  - axial loads resulting from over-strength beam shears
  - actions resulting from in-plane forces in the storey-high cantilever transfer beams
  - vertical earthquake actions
  - code defined actions exceeded by the 22 February 2011 aftershock.
- Wall slenderness ratio that did not meet code requirements for the levels of axial load.
- Insufficient confinement at the base of wall D5-6, in respect to code.
- Insufficient available ductility in the critical wall D5-6 relative to the demands of the 22 February 2011 aftershock.
- Lapping in a wall end/hinge zone.

## 7.0 HOTEL GRAND CHANCELLOR BUILDING

### Stair flights collapse

Analyses carried out under this investigation indicate that:

- the stairs are unlikely to have collapsed under the earthquake actions on 22 February 2011 had the wall D5-6 not failed
- the displacements of the building due to the failure of the wall D5-6 were sufficient to cause collapse of the stairs above Level 14.

Displacements between adjacent floors under design loadings were estimated to be an average of 60mm per floor over the height of the frame. Taking account of tolerances and variability of inter-floor displacement, this dimension could vary by up to 20mm for any one floor. The stair detail provided for 70 to 80mm of horizontal spreading movement of the supports, but there was minimal provision for closing movement. Under the 22 February 2011 ground shaking, the average displacements were estimated to be 65mm per floor.

There was no damage to the stair flights, although there was evidence of damage due to compression at the supports, but it was considered that the stairs did not significantly affect the structural response.

Surveys of the building following the collapse showed that the permanent displacement of the tower in line with the stair was 1000mm. It is likely that a further elastic displacement estimated at 250mm occurred at the time of the failure. Thus the total displacement of the tower at the time of the aftershock was likely to have been about 1250mm, which is 90mm per floor. For any one floor, this displacement could be between 70 and 110mm. When compared with the 70 to 80mm of seating available, this points to a very high likelihood of stair collapse.

## 7.11 Conclusions

Examination and analysis suggests that the building structure was generally well designed. Indeed the overall robustness of the structure forestalled a more catastrophic collapse. However the shear wall D5-6 contained some critical vulnerabilities that resulted in a major, but local, failure. Other shear wall failures of similar appearance have been observed in other buildings following the 22 February 2011 aftershock, and this suggests that a review of both code provisions and design practice is warranted.

## 7.12 Recommendations

This section contains some recommendations arising from observations made during the investigation of the Hotel Grand Chancellor Building and the meetings of the Panel. Some are quite specific to structural features that are contained within the Hotel Grand Chancellor Building and some are more generic, relating to design codes and practice generally. The matters set out below are ones that the Department should give consideration to:

- **Design rigour for irregularity**  
While current codes do penalise structures for irregularity, greater emphasis should be placed on detailed modelling, analysis and detailing. An increase in design rigour for irregularity is required.
- **Design rigour for flexural shear walls**  
The behaviour of walls subject to flexural yielding, particularly those with variable and/or high axial loads, has perhaps not been well understood by design practitioners. An increase in design rigour for wall design generally, and in particular for confinement of walls that are subject to high axial loads, is required.
- **Stair review**  
A review of existing stairs, particularly precast scissor stairs, should be promoted and retrofit undertaken where required.



## 7.0 HOTEL GRAND CHANCELLOR BUILDING

- **Stair seating requirement**

The introduction of larger empirical stair seating requirements (potentially 4%) for both shortening and lengthening should be considered. This should be included in earthquake-prone building policies.
- **Floor-depth walls**

The consequences of connecting floor diaphragms with walls that are not intended to be shear walls requires particular consideration. A Design Advisory relating to walls/beams that are connected to more than one floor, but which are not intended to act as shear walls, should be considered.
- **Design rigour for displacement induced actions**

Designers generally have tended to separate seismically resisting elements from 'gravity-only' frames and other elements of so-called secondary structure. However, not enough attention has always been paid to ensure that the secondary elements can adequately withstand the induced displacements that may occur during seismic actions. Non-modelled elements should perhaps be detailed to withstand 4% displacement. Modelled elements should be detailed to withstand a minimum of 2.5% displacement. An increase in design awareness relating to displacement induced actions should be promoted.
- **Frames supported on cantilevers**

Although this is not a common arrangement, caution needs to be taken when supporting a moment resisting frame on cantilever beams as effective ratcheting can lead to unexpected deflections. A Design Advisory relating to ratcheting action of cantilevered beams and frames should be considered.

# 8.0

## Forsyth Barr Building

### 8.1 Summary

The 18-storey Forsyth Barr Building located on the south-east corner of Armagh and Colombo Streets, Christchurch, suffered an internal collapse of its stairs following the Magnitude 6.3 aftershock on 22 February 2011.

The stairs collapsed on one side of the stairwell up to Level 14, and on the other up to Level 15. The stairs were designed in a “scissor” arrangement, and were the only means of emergency egress from the building.

The stairs as designed met the 1988 design requirements for the prescribed earthquake loads and required seismic gap.

The principal reasons that the stairs collapsed were:

- the intensity and characteristics of the shaking of the 22 February 2011 aftershock exceeded the design capacity of the stairs in terms of distance provided for the stairs to move on their supports in an earthquake (the seismic gap); and
- it is possible that the seismic gaps at the lower supports had been filled with material that restricted movement (including debris, mortar or polystyrene) which reduced their effectiveness.

### 8.2 Investigation

A technical investigation into the reasons for the stair collapse was commissioned by the Department of Building and Housing, and this was undertaken by engineering consultants Beca Carter Hollings and Ferner Ltd (Beca).

## 8.0 FORSYTH BARR BUILDING



Figure 8.1: The Forsyth Barr Building from Armagh Street (looking south-east)

### 8.3 Building description

The Forsyth Barr Building, designed in 1988, is founded on a shallow raft, and its lateral resilience is provided by the frame action of the reinforced concrete beams and columns. For three levels above the Ground Level, the floors extend beyond the footprint of the tower to form a podium on the south and east sides. A typical floor plan is shown in Figure 8.2.

## 8.0 FORSYTH BARR BUILDING

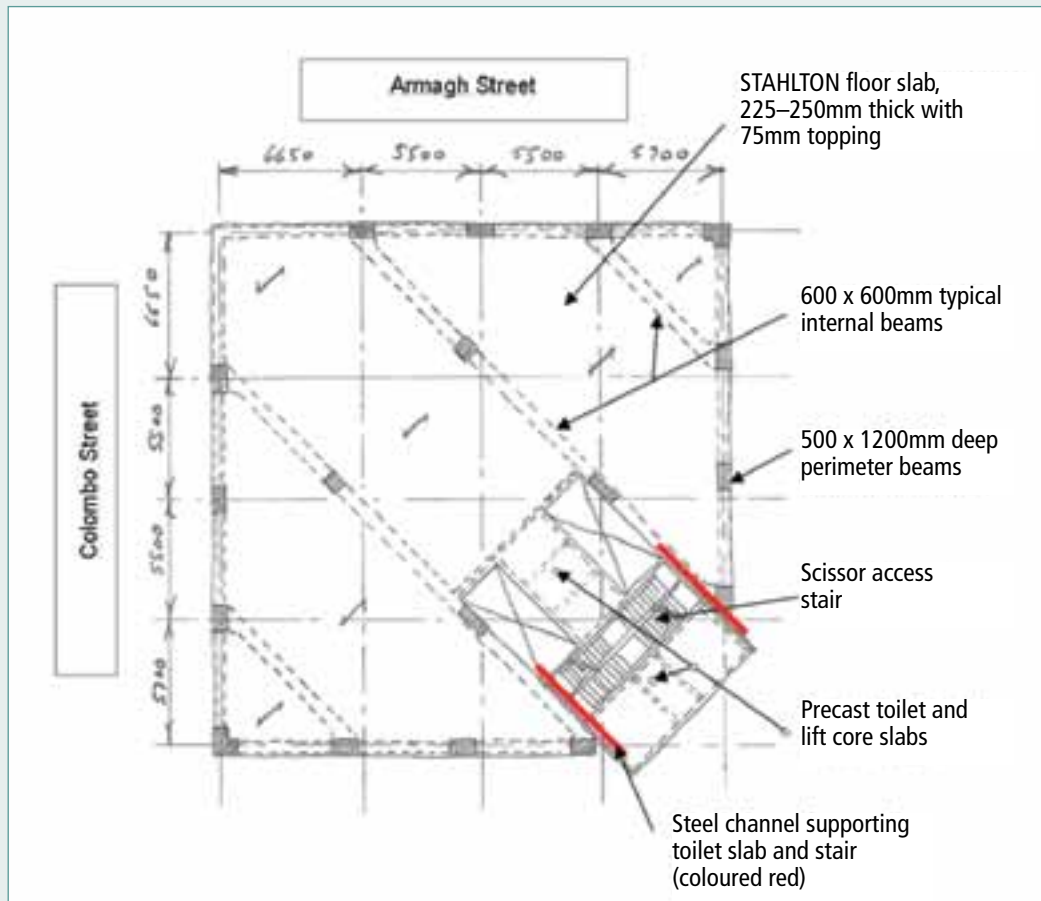

Figure 8.2: Typical floor plan

## 8.0 FORSYTH BARR BUILDING

Emergency egress from the building was provided by a "scissor" stair system. This stair arrangement is exemplified in Figure 8.3.

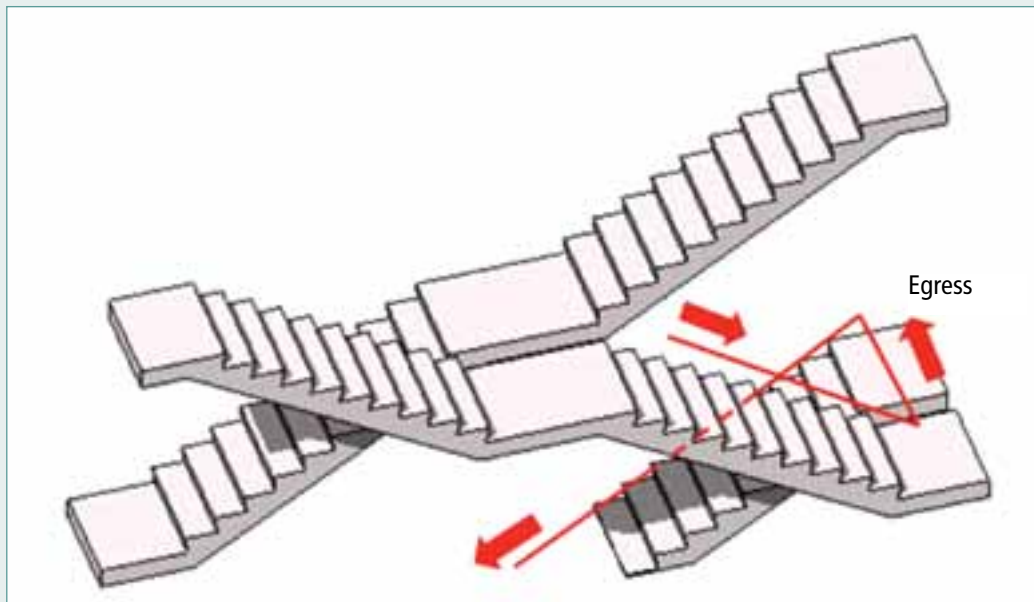

Figure 8.3: 3D view of typical scissor stair system between two adjacent levels

The stairs are orientated diagonally within the tower in a north-east/south-west direction. The majority of the stair flights were pre-cast units cast into the landing at their upper ends, and seated on a steel channel at their lower ends which, in an earthquake, allowed the lower end to slide within limits. This provided a horizontal gap specified at 30mm wide for the closing cycle and 72mm for opening (refer to Figure 8.4).

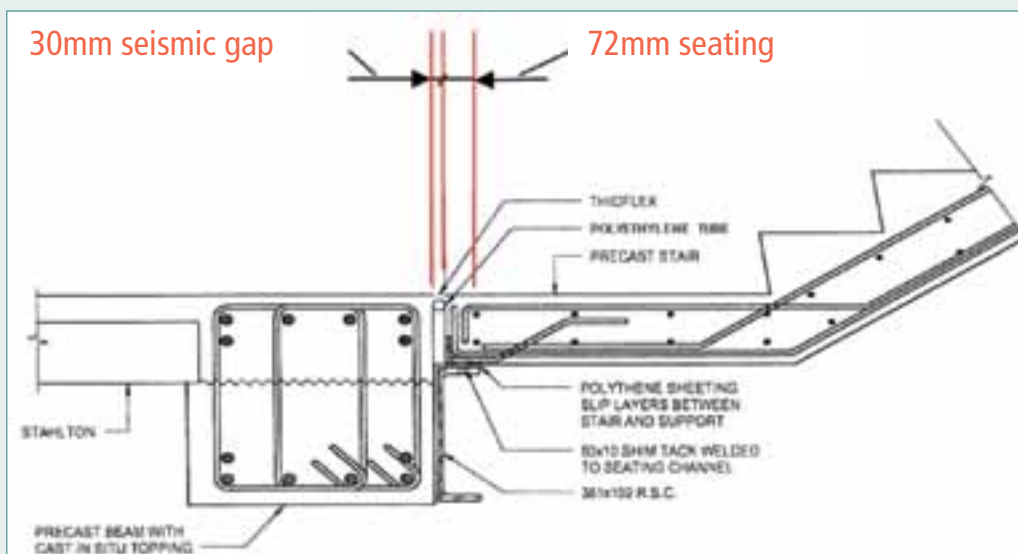

Figure 8.4: Typical stair bottom support detail

## 8.0 FORSYTH BARR BUILDING

### 8.4 Structural modifications

There is no evidence of significant structural changes being made to the building since its construction.

In September 2011, the investigation team were able to inspect the stairs at Levels 14, 15 and 16 by external crane. From this site visit indications that these seismic gaps may not have been constructed in accordance with the drawings were noted.

Evidence was found of modification to the lower end of at least four stair units (two units inspected after removal and two still in place) that may indicate the prescribed seismic gap at that end was not achieved in all cases during construction.

### 8.5 Design basis and code compliance

There were no issues identified to indicate design non-compliance with respect to the code of the day. The seismic gap complied with the code of the day but this 1988 design would be only 80% of current requirements. In other respects a stair system within a building designed in 1988 could be expected to perform to essentially the same level as stairs in a similar building in 2010.

The pre-cast stair units in the tower were designed to be cast into the floor at their upper levels, and to be free to slide horizontally, within limits, at their lower ends. The stairs as designed met the 1988 design requirements for the prescribed earthquake loads.

### 8.6 Geotechnical

Soils data has been obtained from records and from new investigations. These records were used as input data for structural analyses of the building.

Surveys of the site have shown that the foundations of the Forsyth Barr Building did not move significantly, relative to the surrounding ground in the aftershock of 22 February 2011.

### 8.7 Seismological

The nearest permanent seismograph to the Forsyth Barr Building is at the Resthaven Rest Home (REHS) in Colombo Street, about 100 metres south of Bealey Avenue. This is about 800 metres to the north of the Forsyth Barr Building site. The next closest permanent seismographs were in the Botanic Gardens (CBGS, 1.4 km W), near the Christchurch Hospital car parks (CHHC, 1.0 km SW), and near the Catholic Cathedral College in Barbadoes Street (CCCC, 1.3 km SE). Temporary seismographs were installed in the Christchurch Police Station after the 4 September 2010 earthquake.

Information on the soil conditions beneath each station was sought from GNS Science (operators of GeoNet) in order to see whether the conditions were similar to those underneath the Forsyth Barr Building. The softness and layers of the soil beneath a seismograph and a building may have a significant impact on the intensity and frequency content of the shaking they experience.

## 8.8 Effects of 4 September 2010 earthquake and 26 December 2010 aftershock

Minor structural damage was observed after the 4 September 2010 earthquake, including cracking and vertical displacement in some of the stair units and to the floor covering at the landings, cracking in the main structural frame members, and failure of a weld in the region of a car park ramp.

The Level 1 Rapid Assessment undertaken within a few days of the 4 September 2010 earthquake, under the authority of Civil Defence, resulted in the building being tagged Red – Unsafe. This was changed to Yellow – Restricted Access in the course of completing the Level 2 Rapid Assessment undertaken by the property manager’s structural engineer. The building was re-tagged Green – Inspected following a small repair (to the vehicle ramp) and further inspection of the stairs.

Subsequently, the owner’s structural engineer undertook an inspection of the building, and prepared instructions for the repair of cracked structural elements. Instructions had been given for any cracks over a certain size, visible in the stairs, to be repaired by injection of an epoxy grout.

Inspections of the most damaged flights of stairs carried out immediately after the 4 September 2010 earthquake did not reveal there had been any significant movement at the lower support.

Building occupants interviewed have stated that repairs to earthquake damage to floor coverings on the stairs in the period between the 4 September 2010 earthquake and the 22 February 2011 aftershock were underway.

Structural engineers inspected the building after the 4 September 2010 earthquake and the 26 December 2010 aftershock, and advised the owner that it was acceptable to occupy.

There were no reports of further structural damage to the building after the 26 December 2010 aftershock.

## 8.9 Effects of 22 February 2011 event

In the 22 February 2011 aftershock, the Forsyth Barr Building suffered a collapse of the main stairs from the Ground Level to Level 15 (one flight) and from the Ground Level to Level 14 (the other flight). The upper part of a column supporting the south-east corner of the podium roof was also significantly damaged.

The investigation team were able to obtain copies of reports prepared by the building owner’s engineers (dated 31 March 2011 and 13 April 2011) that indicate the damage to the building structure was relatively minor. Laser scanning of the north and west facades of the building, undertaken for Civil Defence, did not indicate any significant permanent distortion of the structure. Although the investigation team inspected the stair units still in place at Levels 14, 15 and 16 in September 2011, it was not possible on that occasion to determine the extent of damage to the building structure.

The removal of the collapsed stair units necessitated cutting them in half at their middle landings, and no records were available of which units were already broken/damaged at their mid-height landings, or from which levels the various pieces originated. Stairs that had been removed from the building after the 22 February 2011 aftershock were tested in terms of core strength of concrete and tensile strength of reinforcing steel. Both concrete and steel properties were found to be consistent with code limits and building specifications. Evidence of cutting/grinding of the lower ends of at least two stair units (presumably to increase the in-place seismic gap) has been seen. It is believed that this occurred during construction.

## 8.0 FORSYTH BARR BUILDING

Analytical models of the structure were subjected to the effects of two seismic events (4 September 2010 and 22 February 2011) by applying records from the nearest GeoNet recording station (REHS, Christchurch Resthaven). In addition, analyses of a typical stair unit were undertaken a) to determine the effect of vertical accelerations, and b) to understand its failure mode if it were to be placed under compression and/or sideways bending due to differential horizontal movement between adjacent floors.

The analyses for the 22 February 2011 event estimated inter-storey drifts between Levels 13 and 14 of 65mm in one direction and 45mm in the reverse direction (refer to Figure 8.5) and these values were used to assess the collapse scenarios.

Analyses for the 4 September 2010 event showed inter-storey drifts between Levels 13 and 14 in the region of 30mm, which corresponded to initiation of damage and compression to the stair flights. This matched the level of damage observed.

### 8.10 Mode of collapse

It seems likely that the uppermost stair units collapsed first, possibly progressively impacting the units below. Interviews with occupants suggested that all the stair collapses occurred during the main shock over a short period of time.

The support at the bottom landing of each stair unit was likely to have been lost first, allowing the unit to pivot downwards about its upper end which was cast into the upper landing. In most cases, the cast-in reinforcing steel at the upper landing has yielded and then snapped, presumably allowing the stair unit to fall down the building in a near-vertical attitude. The investigation team was advised that some of the stair units did not detach from their upper connections, and were left hanging in the stairwell until removed by USAR.

The exact sequence of the stairs collapsing has not been determined. Figure 8.5 details the possible stages involved in the collapse of a stair flight.

On any one stair unit, the lower seating support could have been lost for one of (or a combination of) the following reasons:

- The stair unit has been compressed, resulting in it bending downwards and yielding its reinforcement, because the seismic gap was smaller than needed in the 22 February 2011 aftershock. This resulted in permanent shortening of the stair. On the reversal of the horizontal motion of the floors this shortening was sufficient for the lower landing to fall off its support.
- Analyses completed indicate that inter-storey displacements (drifts) were likely to be highest in the region of Levels 10 to 14.
- The lower stair landing failed in shear when the stair unit was subjected to compression after the seismic gap was closed.
- The effective horizontal length of the stair unit was shortened when struck by the stair unit above, after the unit above lost its seating and rotated downwards about its upper landing. The consequent V-shaped lower unit would then have dragged its lower landing off its seat.
- A free-falling stair unit simply impacted the still-intact unit, causing it to fail catastrophically and fall.
- Construction tolerances and the possibility that the seismic gap at the lower stair support had been filled (with debris, mortar or polystyrene), would have reduced the level of building horizontal displacement required to fail the stair. Even though the stair separation gaps as designed met the code of the day, analyses indicate that the collapse would have occurred even if the joints had been fully free to move.



## 8.0 FORSYTH BARR BUILDING

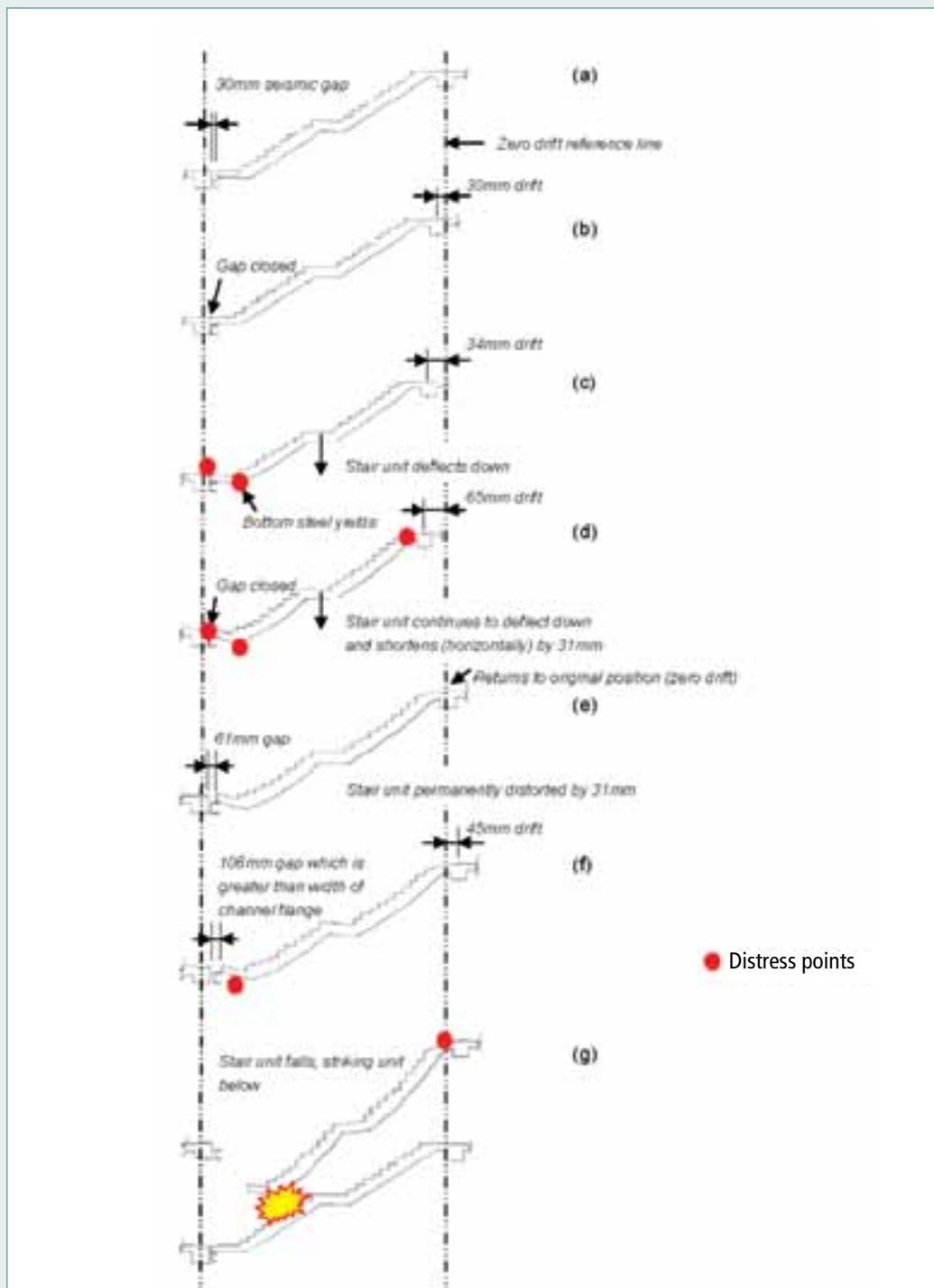

Figure 8.5: Inferred collapse sequence

## 8.0 FORSYTH BARR BUILDING

### 8.11 Probable reasons for stair failure

The actual seismic gaps at the bottom landings were too small for the aftershock shaking experienced on 22 February 2011. The characteristics of the lower seat did not allow any latitude if the building horizontal inter-storey displacements in an extreme event were such that they exceeded the gap provided.

The stair units were not designed to resist compression that would arise from the closing up of the seismic gap.

Construction dimension tolerances (and if, as suspected, the seismic gap at the lower stair support had been filled with debris, mortar or polystyrene) would have reduced the level of relative horizontal displacement between floors required to fail a stair.

The damage observed and/or reported after the 4 September 2010 earthquake and the 26 December 2010 aftershock was not considered to have significantly weakened the stairs to make them more vulnerable in the 22 February 2011 aftershock. Time-history analysis indicated a level of displacement that was consistent with this observation.

### 8.12 Conclusions

Although the seismic gap at the lower stair support met the code of the day, it was too small for the aftershock event of 22 February 2011. There is also evidence that the available seismic gap was not large enough to prevent some stair flights being compressed and slightly damaged during the 4 September 2010 earthquake. The specified gap was sufficient for the shaking experienced in the 26 December 2010 aftershock.

The seismic gap specified on the drawings met the design standards prevailing at the time the building was designed. The specified gap would not have been sufficient to avoid compression if the current (2010) code-derived displacements had been applied.

When comparing the stairs as constructed in the Forsyth Barr Building with the current code, it was found that the original design would not meet current requirements (introduced in 1992) as the 1988 design requirements for clearance between stairs and structure would only be 80% of current requirements.

It could not be definitively established whether the specified seismic gap was provided everywhere, or whether there was debris, mortar or polystyrene in the gaps everywhere, which would have reduced the effectiveness of the gap. Despite the presence of extraneous material in the spaces intended for seismic movement, indications are that the stairs would have collapsed even if this material had not been present and the stairs had been fully free to move.

There was no evidence found in the investigation that indicated that repairs that were underway to the stair coverings prior to 22 February 2011 had an impact on the stair collapse.

The fact that the stairs had been pre-cast as one unit, rather than as two separate units to be connected at mid-height landing, was not considered to have been likely to have had any effect on the collapse.

No evidence (physical or analytical) could be found to suggest that vertical earthquake motion (or response of the stair over its length) experienced in the 22 February 2011 aftershock caused or significantly contributed to the stair failure.

## 8.13 Recommendations

Following the investigation of the Forsyth Barr Building stairs and subsequent discussions with the Panel, a number of issues have arisen that the Department should give consideration to:

- **Alternatives to seismic gap detail**  
Known alternatives to the seismic gap detail used in this building should be used on all new buildings, and for replacing the stairs in this building. These alternatives minimise significantly any likelihood of the stair collapsing because of insufficient displacement allowance.
- **Advisory note for gap-and-ledge stair detail**  
An advisory note that warns of the potential issues and lack of resilience with the gap-and-ledge stair detail for new and existing buildings should be issued.
- **Building Code provision for clearances and seatings for stairs**  
A provision should be included in the Building Code requiring clearances and seatings for stairs to be capable of sustaining at least twice the Ultimate Limit State (ULS) inter-storey displacements, after allowances for construction tolerances.
- **No compromise on seismic gaps**  
The concept that a specified seismic gap must not be compromised under any circumstances should be promoted.

## 9.0

# Principal findings and recommendations

## 9.1 Introduction

This chapter presents principal findings from the investigation and makes recommendations to the Department of Building and Housing on issues identified in the reports on the CTV Building, the PGC Building, the Forsyth Barr Building and the Hotel Grand Chancellor Building. It is recognised that the Department may not carry out the work recommended but will be responsible for the implementation of recommendations.

Although these buildings represent a small sample of the overall building stock affected by the 22 February 2011 aftershock, the issues and recommendations may apply to many other buildings in Christchurch and to other places in New Zealand. Conversely, there may be other issues affecting the performance of buildings not identified in this study.

In presenting these findings and recommendations, the Panel has been aware of the considerable uncertainty surrounding the characteristics of ground shaking at the subject sites and the estimation of actual building response during the aftershock. The analyses and conclusions described in the investigation reports, including postulated collapse mechanisms, need to be interpreted in that light, recognising that there may be other possibilities. Nevertheless, the Panel is confident that the general nature of the findings of the investigations reflects the most likely possibilities.

The chapter presents the principal findings for each of the buildings investigated (section 9.2) followed by the overall findings of the investigation presented by subject matter with associated recommendations (section 9.3). A full list of the recommendations is summarised at the end of this chapter.

These recommendations have been assigned a priority of A (urgent), B (high) or C (moderate) according to the urgency of the need to take action on the recommendation. However, it is important that action is taken on all of the recommendations as soon as possible. The Panel recognises that the Department will need to schedule resources to implement these recommendations.

## 9.0 PRINCIPAL FINDINGS AND RECOMMENDATIONS

# 9.2 Building investigations

The respective chapters on the four buildings in this report present conclusions and recommendations resulting from the investigations. The Panel supports the conclusions of the investigations as to the most likely reasons for, and the modes of, collapse/failure. The following highlights key points of relevance to the recommendations made later in this chapter.

### 9.2.1 CTV Building

A number of possible collapse scenarios were identified. Examination of building remnants, eye-witness reports and various structural analyses were used to evaluate these scenarios. These ranged from collapse initiated by column failure on the east or south faces at mid to high level to collapse initiated by failure of a more heavily loaded internal column at mid to low level. The basic initiator in all scenarios was the failure of one or more non-ductile columns due to the forces induced as a result of horizontal movement between one floor and the next. The amount of this movement was increased by the plan irregularity of the lateral load resisting structure. Additional inter-storey movement due to possible failure of the connection between the floor slabs and the north core may have compounded the situation.

The evaluation was complicated by the likely effect of the high vertical accelerations and the existence of variable concrete strengths. It was further complicated by the possibility that the displacement capacities of columns on the east or south faces were reduced due to contact with adjacent spandrel panels. Many reasonable possibilities exist. In these circumstances it has been difficult to identify a specific collapse scenario with confidence.

The most studied scenario, which was consistent with eye-witness reports of an initial tilt of the building to the east, involved initiation by failure of a column on the mid to upper levels on the east face. Inter-storey displacements along this line were higher than most other locations and there was the prospect of premature failure due to contact with the spandrel panels. Loss of one of these columns on the east face would have caused load to shift to the adjacent interior columns. Because these were already carrying high vertical loads and were subjected to lateral displacements, collapse would have been likely.

The low amount of confinement steel in the columns and the relatively large proportion of cover concrete gave the columns little capacity to sustain load and displacement once strains in the cover concrete reached their limit. As a result collapse was sudden and progressed rapidly to other columns.

Once the interior columns began to collapse the beams and slabs above fell down and broke away from the north core. The south wall together with the beams and columns attached to that wall then fell northwards onto the collapsed floors and roof.

Other scenarios considered had different routes to the failure of a critical column, but in all cases, once the critical column failed, failure of other columns followed.

In reviewing the issues arising from the CTV Building investigation, the Panel concludes as follows:

- a) Geometrically irregular structures may not perform as well as structural analyses indicate. Limitations on eccentricity should be reviewed, limits tightened and the concerns brought to the attention of structural engineers and territorial authorities.
- b) Particular attention should be given to the evaluation of the actual displacement capacity of gravity-load bearing columns designed according to pre-1995 code provisions. Buildings designed before 1995 with non-ductile columns may be unacceptably vulnerable. They should be checked and a retrospective retrofit programme considered. The minimum confinement requirements for gravity-load bearing columns in 'secondary' structural systems must be reviewed.

## 9.0 PRINCIPAL FINDINGS AND RECOMMENDATIONS

- c) Adequate attachment of floors to shear walls must be achieved. The methods of assessment of the forces involved and of effective methods to provide for them require re-evaluation. Buildings designed to the provisions of NZS 4203 prior to 1992 should be subject to particular attention, including consideration of the need for retrofit action.
- d) There is a need to assess minimum clearance requirements to non-structural components (eg spandrel panels and infill walls) that may detrimentally affect structural performance. Greater awareness of the importance of these requirements is needed amongst structural designers, architects, territorial authorities and builders.
- e) There is a need for improved confidence in design and construction quality. Measures need to be implemented which achieve this. Design Features Reports should be introduced and made mandatory. Designers must have an appropriate level of involvement in construction monitoring. There should be a focus on concrete mix designs, in-situ concrete test strengths, construction joint preparation and seismic gap achievement. There is a need to check the strength/quality of concrete achieved in a range of structures throughout the country.

### 9.2.2 PGC Building

The lack of ductility and strength inherent in the 1963 standards and the strong shaking combined to fail the eastern wall of the building's shear core. The resulting horizontal displacement of the floors led to the failure of the columns and beam-column joints, causing the floors to collapse on top of one another.

In reviewing the issues arising from the PGC Building investigation, the Panel concludes as follows:

- a) Walls with centrally located and light reinforcement may be susceptible to failure when significantly overloaded. In such walls the concrete carrying compressive loads is not confined by reinforcement and will therefore behave in a brittle fashion.
- b) Older buildings may lack redundancy and be vulnerable if they have only one lateral load resisting system or no alternative load path.
- c) Columns and walls that are not regarded as contributing to earthquake resistance must be capable of sustaining the expected inelastic lateral displacements of the structure.

### 9.2.3 Hotel Grand Chancellor Building

The failure of a critical shear wall was caused by extremely high axial stresses resulting from both horizontal and vertical irregularity and bi-directional loadings. The high axial stresses combined with low levels of confinement reinforcing at the base of the wall resulted in a brittle failure of the wall.

The building irregularity and the critical wall's vulnerability were increased as a result of a design change during construction when permission to support the east face of the building on foundations located in Tattersalls Lane was declined.

High seismic vertical accelerations are likely to have further increased the axial loads/stresses beyond those expected. The inherent redundancy and resilience of the remaining structure prevented total collapse.

A number of other wall failures which had the appearance of high axial stresses and low confinement levels were observed in buildings following the 22 February 2011 aftershock.

In reviewing the issues arising from the Hotel Grand Chancellor Building investigation, the Panel concludes as follows:

- a) Vertical accelerations must be considered in situations where there is not a direct load path to the ground (ie horizontal cantilevers) and transfer beams.
- b) Minimum confinement requirements in wall/columns of the type that failed should be reassessed.
- c) Maximum axial stresses in columns/walls should be reviewed to improve resilience.
- d) Slenderness ratio limitations for such walls need to be checked.

## 9.0 PRINCIPAL FINDINGS AND RECOMMENDATIONS

### 9.2.4 Forsyth Barr Building stairs

The strong shaking caused the building to sway beyond design expectations current at the time of the building design. The seismic movement gap at the base of the stair flights was not sufficient to avoid compression in the stair flights. The prescribed seismic gap may not have been achieved in all cases during construction. Material was also found in the spaces intended for seismic movement in the stairs. This extraneous material may have exacerbated the compression actions that shortened the flights making the collapse of the stairs more likely. However, indications are that the collapses may have occurred even if the stairs had been fully free to move. The collapses may not have occurred if current (2010) design allowances for inter-storey movement had been provided.

While the stair seating detail used at the base of the Forsyth Barr stair units was not widely used, a number of other stair details that were commonly used during the 1980s and 1990s do not provide for sufficient movement when analysed against current seismic displacement expectations. These types of stair connections, together with stairs designed prior to 1976, which commonly have no provision for movement, are likely to require some retrofit.

In reviewing the issues arising from the Forsyth Barr Building investigation, the Panel concludes as follows:

- a) Egress stairs must be designed to maintain their structural integrity until the building structure is on the point of collapse.
- b) Scissor stairs inherently have less reliability than other stair systems because loss of one flight can result in the loss of the entire egress route. Conservatism is therefore advised.
- c) Gap and ledge support arrangements are problematical and conservatism is advised or an alternative arrangement recommended.
- d) Seismic gaps must remain completely clear and must not be reduced by construction tolerances, debris etc.
- e) Ledges must be generous and evaluated according to expected demand at point of collapse of the building.

## 9.3 Findings and recommendations

The Panel considered the issues raised in the investigations of the four buildings and as a result identified a range of principal findings and associated recommendations for action. The findings and recommendations are set out below and have been grouped under logical subject-headings for ease of implementation.

### 9.3.1 Ground shaking/building response

#### 1. Estimating building response:

The estimated responses of buildings to recorded ground shaking in the Christchurch CBD on 22 February 2011 are shown, in most cases, to be significantly greater than those used in 2010 as a basis for the design of new buildings of the type in the investigations. The investigations highlighted the variability and uncertainty involved in estimating building response from ground shaking measurements.

The earthquake was shallow and very close to Christchurch City, so the intensity of ground shaking in this event (as indicated by the response spectra) was much higher than in the Darfield event.

#### 2. Vertical accelerations:

The vertical accelerations measured in the 22 February 2011 aftershock were exceptionally high and may have contributed significantly to vertical forces in columns and walls. The extent of this contribution is generally difficult to quantify, but analyses of the CTV Building indicated that vertical accelerations could have reduced the capacity of critical columns to sustain lateral displacements by around 15 to 35% depending on concrete strength.

## 9.0 PRINCIPAL FINDINGS AND RECOMMENDATIONS

### 3. Duration of shaking:

The duration of the 22 February 2011 aftershock was relatively short. A longer duration earthquake is likely to have had a greater effect on buildings, especially on structures that are not well tied together or are not properly detailed in their critical connection regions. It is important that the implications of longer duration shaking be better understood, in particular when assessing the earthquake performance of existing buildings. The availability of extensive ground motion records and information on modern building performance offers an opportunity to improve such understanding and revise current assessment/design/retrofit methodologies.

### 4. Seismic hazard coefficients for building design:

The logic of consideration of large infrequent earthquakes within a uniform risk environment should be re-examined. In particular, the basis for determining seismic hazard coefficients for building design needs to be looked at. Consideration of the consequences of a large earthquake occurring in or near a major urban centre, including the national economic impact, should also be investigated.

## Recommendation 1: Ground shaking/building response

### (Priority A)

Bring together a comprehensive study that examines the seismic response/performance of buildings in the Canterbury earthquakes, particularly the 4 September 2010 earthquake and the 22 February 2011 aftershock.

Such a study should relate building performance (for older and new buildings) and ground shaking measurements, and be aimed at improving the effectiveness and efficiency of earthquake-resistant design in New Zealand and elsewhere.

The study should address:

- the methods and assumptions used in building design, analysis, standards and practices
- the influence of vertical ground motions
- the effects of duration of earthquake shaking
- the basis for determining seismic hazard factors for building design, assessment and retrofit, particularly for large urban centres.

## 9.3.2 Geotechnical

### 1. Liquefaction effects:

The effects of liquefaction and lateral spreading were not significant for any of the four buildings in the investigation.

### 2. Foundation distress:

Foundation distress was not a factor in the collapses or failures of buildings. There was no evidence of significant foundation settlement or failure in any of the buildings.

### 3. Geotechnical information:

In spite of the above findings, the Panel was concerned at the level of information on site soil conditions used as a basis for decisions on foundations. The level of geotechnical investigation for the subject buildings was noticeably less than is typical for buildings in Auckland and Wellington.



## 9.0 PRINCIPAL FINDINGS AND RECOMMENDATIONS

### Recommendation 2: Geotechnical

#### (Priority B)

Review geotechnical information standards required for urban areas in New Zealand and develop national guidelines for minimum standards of information.

#### 9.3.3 Post-earthquake inspections

##### 1. Inspections following damaging earthquakes:

From the information available, it appears that the 4 September 2010 earthquake and the 26 December 2010 aftershock did not significantly reduce the earthquake resistance of any of the four buildings. Nevertheless there is a need to clarify the requirements and expectations of inspections of buildings damaged by earthquakes. This includes the rapid assessments done under civil defence emergency and those done on behalf of the owner or other authorities. Special efforts are needed to improve the public understanding of what the inspections can and cannot achieve.

##### 2. Post-earthquake inspections – documentation:

The documentation required for and resulting from post-earthquake inspections needs to be made publicly available and recorded on Council property files. Special efforts are also required to make sure that information that is a) required for post-earthquake building inspections and b) results from post-earthquake building inspections has appropriate electronic back-up systems so that it is able to be accessed remotely in an emergency situation.

##### 3. Legislative provisions:

There is a need to better align the powers available with respect to building safety during a state of civil defence emergency and those in the Building Act. The legal status of safety assessments made in the emergency period needs to be clarified and the transition from Civil Defence Emergency Management Act to Building Act aligned.

This may require changes to the Building Act to include specific provisions for the structural assessment and rehabilitation of buildings affected by earthquakes.

### Recommendation 3: Post-earthquake inspections

#### (Priority A)

Review current methods for inspecting and reporting information on the structural condition of buildings following an earthquake.

Such a review should address:

- the need for legislation covering the structural assessment and rehabilitation of buildings affected by earthquakes
- the extent to which building owners are responsible for undertaking a more detailed evaluation of their buildings following earthquakes
- the need for public awareness and owner education programmes to improve the general understanding of the roles of post-earthquake inspections/evaluations and their limitations
- legislative requirements for the documentation of post-earthquake inspection information and public accessibility to such information.

## 9.0 PRINCIPAL FINDINGS AND RECOMMENDATIONS

### 9.3.4 Structural design – general issues

The investigations highlighted the need to re-examine some general and some specific aspects of structural design to draw on the experience of the Canterbury earthquakes. The issues identified centre on the importance of integrity, ductility and robustness in earthquake-resistant structures, the need to limit irregularity of structural form, and the need to avoid unintended interactions of structural elements with other building components. The general structural design issues are outlined in this section (9.3.4) and the more specific structural design issues in the following section (9.3.5).

#### 1. Encouragement of higher standards than code minimums:

The Building Code and related Standards define minimum performance requirements for buildings. A modern building designed according to the current requirements would be expected to suffer significant damage when subject to an intensity of shaking equivalent to that used in its design. Owners and designers need to be encouraged to recognise that achieving higher than the minimum required performance requirements may be more cost-effective, especially if the property market puts a value on good seismic performance.

There is a need to:

- check that minimum structural performance standards match community expectations
- encourage consideration by owners and designers of the value of achieving more than the minimum standards.

#### 2. Structural integrity:

The failure of the CTV Building in particular has highlighted the need for a high degree of integrity (tying together and resilience) of buildings subject to earthquake actions. Greater emphasis on overall structural integrity of buildings is needed.

The Panel is concerned that requirements for the design of structures, particularly reinforced concrete structures, are becoming dominated by excessively detailed procedures and calculations at the expense of attention to the basic fundamentals of structural mechanics that are essential to achieve structural integrity and robust load paths.

There is a need to reassess and simplify the requirements for reinforced concrete design so as to place more emphasis on the need for overall structural integrity and robust load paths.

#### 3. Designing resilient buildings:

The importance of resilience and redundancy was demonstrated during the aftershock by the Hotel Grand Chancellor Building which did not collapse despite the failure of a load bearing wall. In contrast, the collapses of the CTV and PGC buildings highlighted the lack of alternative load-paths or back-up mechanisms in the seismic response. Redundancy within seismic and gravity load paths should be provided wherever possible.

Design approaches need to be re-evaluated and changed as necessary to include specific provisions to avoid progressive and disproportionate collapse in multi-level and large buildings.

#### 4. Irregular structures:

Structural irregularity, both horizontal and vertical, was a feature of three of the four buildings in the investigation, and in all three cases the irregularity had a detrimental effect on the response of the structure. While codes and standards address the issue of irregularity, the Panel questions the effectiveness of design practice (analysis and detailing) in this area, particularly when post-elastic actions and displacements are considered.

Every effort should be made to avoid irregularity in structures. Greater design rigour is needed for buildings with irregularity (horizontal or vertical). More recognition is needed amongst structural designers and architects of the special demands on critical members that can result from structural irregularity and the need to detail these members accordingly.

Greater recognition of the variability and uncertainties associated with design calculations for irregular structures is needed in the training of structural engineers.

## 9.0 PRINCIPAL FINDINGS AND RECOMMENDATIONS

### 5. Capacity design approach:

Capacity design refers to a design process which limits forces in some structural members in order to protect others (eg a weak, but ductile, beam/strong column approach protects columns).

There was evidence in the Hotel Grand Chancellor and the Forsyth Barr buildings that were damaged and yet did not collapse that the capacity design approach helped provide sufficient resilience to prevent total failure. This reinforces the value of the capacity design approach to building design in areas of seismic hazard.

Capacity design principles are vital in controlling the response of structures in the face of variability and uncertainties in the ground motions that may be experienced. There are indications that these principles need reinforcing amongst designers.

A number of actions need to be considered in relation to the capacity design approach:

- Placing more incentives in design standards to encourage the use of the capacity design approach, even in regions of low seismicity. This could include requiring redundancy in buildings and ductile detailing even for elastically designed structures.
- Requiring that designers apply the capacity design approach to the whole building down to the most brittle mechanism/weakest link in the building, not just to the individual components.
- Facilitating professional development of structural designers in this conceptual design approach.

### 6. Displacement demand:

In the design of new buildings, and the assessment of existing buildings, greater emphasis should be placed on the displacement demand on the structure and the capacity of the structure to accommodate the displacements. This is particularly important when considering the compatibility of elements intended to remain elastic (eg floor diaphragms are affected by frame elongation) and also for secondary structural elements (eg gravity columns subjected to lateral sway). Design should be considered as sustaining load-carrying capacity and integrity as the building deforms. This will highlight displacement incompatibilities.

Building designers should be re-educated on the need to regard earthquake actions in structures as being displacement-induced rather than force-induced.

### 7. Unintended structural inter-actions:

Unintended effects on the structure by elements such as block walls, spandrel panels and stairs have highlighted, once again, the importance of allowing the structure to deform without the unintended contribution to or detrimental effect of these elements on structural response.

There is a need to reassess the allowances for separation and/or connection of secondary/non-structural elements in design standards and implement any changes required.

### 8. Critical vulnerability factors:

The buildings that were the subject of the investigation displayed a range of vulnerabilities which, in part, were due to the era in which they were built. Previous design codes and philosophies involved differing structural systems and detailing, differing connection systems between elements and differing seismic resisting systems to those that are applicable today. These vulnerabilities resulted in potential structural weaknesses which could have contributed to the collapse/failure of the buildings. Some examples of these vulnerabilities include a lack of capacity design, poor anchorage details, lack of stirrups in the joint region, inadequate confinement and reinforcement in columns and walls, poor detailing of the plastic hinge regions, irregularity in plan and elevation, and inadequate connections between lateral load-resisting systems and floor-diaphragm.

In order to improve the seismic performance of buildings, designers and reviewers should focus on critical vulnerability factors when designing buildings.

## 9.0 PRINCIPAL FINDINGS AND RECOMMENDATIONS

### 9. Design Features Reports:

Design Features Reports that summarise key information about the design intentions, material properties, structural configuration and other important structural characteristics are a valuable tool in the quality assurance of a building. Almost every building is a “one-off” and what is built and used is the first and only attempt to get it right. There needs to be greater attention to quality assurance checking when buildings are designed and built as there may be no chance to correct mistakes once a building is completed.

To improve the quality of construction, consideration should be given to making it compulsory for a two part “Design Features Report” to be produced for all buildings (other than a single family dwelling) with significant structural engineering content. Part one would cover designs submitted for building consent. Part two would cover the completed work.

It is suggested that the Design Features Report should include:

- a description and schematics of the conceptual design process and design measures adopted to provide structural integrity and redundancy
- definition of alternative load paths or “back-up” mechanisms to prevent disproportionate collapse in case of failure of a single vertical load-bearing element
- identification of the most vulnerable elements (weak links) and mechanisms in the structure
- a description of potential building collapse mechanisms and scenarios
- remediation measures to reduce the risk of a partial or total collapse of a building.

It is suggested that the structural engineer responsible for the design of the building should be engaged to carry out the site observations of the works during the construction phase, to monitor critical features as they are constructed. That design engineer would be able to nominate another engineer provided that engineer could demonstrate familiarity with the design intentions and the overall design process followed for the particular building.

Suitable Design Features Report templates need to be developed that best serve the needs of designers and territorial authorities.

### 10. Earthquake strengthening when a building is altered or its use is changed:

Current legislation and territorial authority practices should be reviewed with a view to tightening the requirements for earthquake strengthening when buildings are altered or their use changed.

## Recommendation 4: General structural design issues

### (Priority A)

Reassess approaches to and general requirements for achieving earthquake resistance in buildings. See that necessary changes are made in the light of the Canterbury earthquakes.

Specifically, amendments should be aimed at:

- improving structural integrity and resilience
- limiting the irregularity of structures
- encouraging capacity design
- encouraging displacement-based approaches to design and assessment
- avoiding unintended interactions between structural and other parts of a building
- identifying and removing critical vulnerabilities
- introducing compulsory Design Features Reports for significant buildings – new or retrofit
- introducing tighter controls to trigger requirements for earthquake strengthening when buildings are altered or their use changed.

## 9.0 PRINCIPAL FINDINGS AND RECOMMENDATIONS

### 9.3.5 Structural design – specific issues

#### 1. Walls and columns:

The failure of a major wall in the Hotel Grand Chancellor, the collapse of columns in the CTV Building, and the failure of lightly reinforced walls in the PGC Building are of serious concern. In the case of existing buildings, such as the PGC and CTV buildings, the lack of strength and ductility was an issue that may require building retrofits.

The Panel has identified a need to:

- review aspects of the requirements for the design, detailing and construction of walls and columns to include consideration of vertical accelerations and lateral sway
- improve ductility capacity and confinement steel to maintain load-carrying capacity in the face of unexpectedly large displacements
- consider legislative/regulatory action to require prompt and effective retrofit measures
- consider the need for retrospective action on buildings, especially those built before 1995 with non-ductile columns.

Changes in design requirements need to be considered, including the following:

- Further limitation on axial stress levels in columns and walls. These must be evaluated with appropriate consideration of bi-directional loading.
- Reduction of slenderness ratio to avoid member buckling failure in the core.
- More stringent detailing for ductility and confinement, whether or not walls or columns are intended to be a primary part of the earthquake-resisting structure.
- Greater emphasis on and practitioner understanding of bi-directional effects and detailing to accommodate lateral displacements.

#### 2. Lightly reinforced shear walls:

Reinforced concrete shear walls like those in the PGC Building are particularly vulnerable in severe earthquake shaking. Usually the reinforcing steel is a central layer and there is no confining steel. This type of construction could have been used in buildings built before 1965 and possibly as late as 1976. This construction method is still used in low seismic areas. Such buildings are not usually classified as earthquake-prone under the Building Act 2004.

There is a need to alert owners of buildings that have lightly reinforced concrete shear walls to their potential vulnerability to collapse in a major earthquake. Owners with concerns should seek advice on necessary structural improvements from a Chartered Professional Engineer.

The vulnerabilities of lightly reinforced shear walls should be covered in the New Zealand Society for Earthquake Engineering assessment guidelines.

#### 3. Limits on axial load levels:

The collapse of the CTV Building and the wall failure in the Hotel Grand Chancellor Building underline the vital importance of the load-carrying capacity of columns and walls and the need for them to be resilient when subject to earthquake movements and actions. The high vertical accelerations experienced in the 22 February 2011 aftershock provide additional reasons to adopt conservative overall limits to axial stresses computed for design purposes. Such a move would be in line with practice in other countries. Consideration should be given to further limiting axial load ratios in columns and walls.

A review is needed of requirements in design standards that place limits on compressive stresses in walls and columns. More conservative requirements should be considered.

## 9.0 PRINCIPAL FINDINGS AND RECOMMENDATIONS

### 4. Buildings with cantilevers and/or transfer beams:

The Hotel Grand Chancellor wall failure highlighted the critical role of the supports to cantilever beams and their particular vulnerability when subject to loads in excess of those expected, such as the effects of vertical acceleration and post-elastic deflections. Cantilever beams and/or transfer beams will tend to progressively deflect downwards (ratchet) when subjected to cyclic post-elastic yielding. Cantilever beams and transfer beams that support frames may be particularly vulnerable to this as a result of seismically induced axial actions in the frames.

There is need to:

- reassess requirements for the design of buildings with cantilevers and transfer beams and implement changes where appropriate
- promote caution amongst designers when supporting a moment resisting frame on cantilever beams or transfer beams, particularly to counter “ratcheting” that can lead to unexpected deflections.

### 5. Diaphragm connections:

Detailed analyses, particularly those undertaken for the CTV Building, highlighted the importance of connections between floor slabs and structural walls that provide lateral resistance. In particular, it was shown that diaphragm forces may be much greater than are currently estimated for design purposes.

There is a need for a review of design requirements across a range of buildings. This should include a special investigation into the performance of floor-diaphragm connections in the Christchurch earthquakes. New requirements will need to be developed and implemented.

## Recommendation 5: Specific structural design issues

### (Priority A)

Review detailed design requirements for structural design and amend them to resolve concerns identified in relation to:

- strength and ductility of walls and columns
- vulnerability of lightly reinforced concrete shear walls
- limits on axial load levels
- vulnerability of buildings with cantilevers and transfer beams
- strength and integrity of diaphragm connections.

### 9.3.6 Stair design

#### 1. Stair design:

The investigation of the Forsyth Barr Building highlighted the need for the approach or methodology adopted for stair design to be reassessed in terms of displacement capacity. Changes in approach to stair support design are required.

For all new or refurbished buildings the main egress routes need to remain functional and be available to the building occupants to allow them to exit the building safely in the event of a fire or earthquake.

To this end, stair supports need to be designed to have a sufficient displacement capacity so that stair collapse is not expected to occur before building collapse. This will require allowances for displacements well above those estimated to occur at the ultimate limit state of the structure.

Consideration needs to be given to extending the protection of the egress routes so that in multi-storeyed buildings the final exit way to the exterior of the building is provided with robust impact barriers to protect the occupants exiting the building from falling debris.

## 9.0 PRINCIPAL FINDINGS AND RECOMMENDATIONS

Reviews are needed to check the following:

- Provisions for movement are in line with current requirements. Buildings built before 1992 may have stairs with allowances for inter-storey displacements that are less than currently required or considered adequate.
- Support and separation details are such that they are not compromised by unintended restrictions to movement under earthquake actions.
- Progressive collapse is avoided.
- Allowances for variations in constructed dimensions are provided.

There is a need to develop revised criteria for stair support and to implement the new requirements in relevant design standards. NZSEE and SESOC will need to promote awareness of the new requirements.

### Recommendation 6: Stairs

#### (Priority A)

Issue a Practice Advisory to warn owners of buildings, especially those in flexible frame buildings, to check that the stairs are designed to accommodate appropriate levels of earthquake-induced displacements. (This is a recommendation from the Stage 1 Report and since that time the Department issued Practice Advisory 13: Egress Stairs: Earthquake checks needed for some, published September 2011 [www.dbh.govt.nz/practice-advisory-13](http://www.dbh.govt.nz/practice-advisory-13)).

Develop revised criteria for stair support and protection of egress ways and incorporate them into the requirements for new designs and retrofits.

### 9.3.7 Construction quality and compliance

#### 1. Construction quality:

Buildings are usually "one-offs" and special attention is needed to see that the design intentions are followed. The investigation highlighted the need for more attention to be paid to the quality of construction, particularly in the areas of quality control, quality assurance, construction monitoring, design review and construction skills. The method for checking quality through all phases of the building cycle, from design to construction monitoring, requires review. One specific aspect identified in the investigations was the need to check the strength and quality of concrete used in buildings.

#### 2. Compliance and monitoring:

The present regulatory system is dependent on the various parties in the overall design and construction process all having different responsibilities, with the risk that errors or omissions may be overlooked. Building Consent Authorities currently have a high level of responsibility in granting building consents and certifying Code compliance for complex buildings. Design professionals should have a continuing responsibility throughout the entire design and construction process. This is likely to induce a cultural change in favour of improving the overall quality of construction work and help to minimise the risk of building failure.

Current practices for construction monitoring need to be looked at in order to achieve more effective monitoring and site supervision by those familiar with the design intentions. The Panel strongly believes that the structural engineers responsible for the design of buildings which have a significant structural engineering content should be engaged to observe the works during the construction phase and be in a position to certify that the building has been built to the approved design

## 9.0 PRINCIPAL FINDINGS AND RECOMMENDATIONS

### Recommendation 7: Construction quality and compliance

#### (Priority B)

Review quality assurance processes in all phases of building design and construction, especially in light of the findings of these building investigations. Implement tighter controls and promote more designer involvement to ensure that design intentions are being achieved and that the work complies with the requirements of the approved design documents.

#### 9.3.8 Concrete quality

Concrete strength was an important factor in the investigation of the CTV Building, with lower than expected strengths found in several columns. The Panel is concerned that there is very little evidence or record of the strength of concrete in its as-placed condition and that there should be a comprehensive survey across a range of building types and construction eras. This survey should check that measured concrete properties are in line with expectations and identify any required changes to standards and procedures. The aim would be to better inform those responsible for building safety standards and to identify any critical issues.

### Recommendation 8: Concrete quality

#### (Priority C)

Work with the concrete industry to review the in-situ strength of concrete achieved in a representative range of buildings around New Zealand and recommend any measures required to provide the necessary confidence that specified concrete strengths have been and will be achieved. Measures considered should include further strength testing of in-situ concrete in existing buildings and revisions to standards and procedures covering the manufacture, delivery, placement and curing of concrete in new buildings.

#### 9.3.9 Earthquake-prone buildings

##### 1. Definition of earthquake-prone buildings:

The Panel recognises that this topic will be covered by the Royal Commission, and across a wider range of buildings, but the consultants' findings that the PGC and CTV buildings could have been classified as not earthquake-prone has caused the Panel to consider the need for changes in the legislation and/or approaches for earthquake-prone buildings.

##### 2. Higher risk urban centres:

New Zealand has a disproportionately high percentage of national wealth located in a small number of urban centres, the loss of any one of which (eg Christchurch) can have extreme consequences to the country as a whole.

There should be a review of the risk level and performance of buildings of low earthquake resistance, particularly in regions of high population density. The review should also assess the risk and cost to the country of a major earthquake in various parts of the country. Consideration should be given to setting different earthquake-prone thresholds for different parts of the country. For example, urban centres over a certain population size should be required to set their earthquake prone level at a higher %NBS.



## 9.0 PRINCIPAL FINDINGS AND RECOMMENDATIONS

### 3. Public safety:

There should be an assessment of all unreinforced masonry buildings (URMs), especially those contiguous to a public street, to make sure they do not pose any risk to people in or near the building. Structural bracing to unreinforced masonry elements should be required to prevent collapse.

On all new buildings where there are designed pediments or other architectural features on the street facade, the pediments should be restrained and/or the verandas should be designed as impact barriers to protect the passers-by or other users of the street.

### 4. Public awareness of earthquake risk:

The Panel considered that there was a lack of public awareness that many buildings which are not classified as earthquake-prone under the Building Act 2004 may nevertheless collapse in a major earthquake. These are buildings rated more than 33%NBS but significantly less than 100%NBS. The probability of such collapse could be significantly reduced by strengthening/retrofit measures that increase earthquake resistance and expected performance. The public also need to be made aware of the importance of achieving earthquake resistant buildings and the methods available to increase earthquake resistance.

## Recommendation 9: Earthquake-prone buildings

### (Priority A)

Promote and implement measures, and associated enforcements and incentives, that would result in:

- improved definitions of earthquake-prone buildings and more effective implementation of strengthening measures, particularly for buildings likely to fail in a brittle manner
- a stronger appreciation of the (private and public) value of good seismic performance of buildings and the benefits of improvement action
- effective and economic retrofit strategies that improve the earthquake safety of buildings
- adoption by territorial authorities of strongly active policies to reduce the risk posed by buildings of low earthquake resistance
- improved public awareness that buildings not classified as earthquake-prone under the Building Act 2004 but which fall short of 100%NBS may nevertheless collapse in a major earthquake.

## 9.0 PRINCIPAL FINDINGS AND RECOMMENDATIONS

### 9.4 Summary of recommendations

The Panel makes the following recommendations to the Department of Building and Housing as a result of the technical inquiry into the structural performance of Christchurch CBD buildings in the 22 February 2011 aftershock:

#### Recommendation 1: Ground shaking/building response

##### (Priority A)

Bring together a comprehensive study that examines the seismic response/performance of buildings in the Canterbury earthquakes, particularly the 4 September 2010 earthquake and the 22 February 2011 aftershock.

Such a study should relate building performance (for older and new buildings) and ground shaking measurements, and be aimed at improving the effectiveness and efficiency of earthquake-resistant design in New Zealand and elsewhere.

The study should address:

- the methods and assumptions used in building design, analysis, standards and practices
- the influence of vertical ground motions
- the effects of duration of earthquake shaking
- the basis for determining seismic hazard factors for building design, assessment and retrofit, particularly for large urban centres.

#### Recommendation 2: Geotechnical

##### (Priority B)

Review geotechnical information standards required for urban areas in New Zealand and develop national guidelines for minimum standards of information.

#### Recommendation 3: Post-earthquake inspections

##### (Priority A)

Review current methods for inspecting and reporting information on the structural condition of buildings following an earthquake.

Such a review should address:

- the need for legislation covering the structural assessment and rehabilitation of buildings affected by earthquakes
- the extent to which building owners are responsible for undertaking a more detailed evaluation of their buildings following earthquakes
- the need for public awareness and owner education programmes to improve the general understanding of the roles of post-earthquake inspections/evaluations and their limitations
- legislative requirements for the documentation of post-earthquake inspection information and public accessibility to such information.

## 9.0 PRINCIPAL FINDINGS AND RECOMMENDATIONS

### Recommendation 4: General structural design issues

#### (Priority A)

Reassess approaches to and general requirements for earthquake resistance in buildings. See that necessary changes are made in the light of the Canterbury earthquakes.

Specifically, amendments should be aimed at:

- improving structural integrity and resilience
- limiting the irregularity of structures
- encouraging capacity design
- encouraging displacement-based approaches to design and assessment
- avoiding unintended interactions between structural and other parts of a building
- identifying and removing critical vulnerabilities
- introducing compulsory Design Features Reports for significant buildings – new or retrofit
- introducing tighter controls to trigger requirements for earthquake strengthening when buildings are altered or their use changed.

### Recommendation 5: Specific structural design issues

#### (Priority A)

Review detailed design requirements for structural design and amend them to resolve concerns identified in relation to:

- strength and ductility of walls and columns
- vulnerability of lightly reinforced concrete shear walls
- limits on axial load levels
- vulnerability of buildings with cantilevers and transfer beams
- strength and integrity of diaphragm connections.

### Recommendation 6: Stairs

#### (Priority A)

Issue a Practice Advisory to warn owners of buildings, especially those in flexible frame buildings, to check that the stairs are designed to accommodate appropriate levels of earthquake-induced displacements. (This is a recommendation from the Stage 1 Report and since that time the Department issued Practice Advisory 13: Egress Stairs: Earthquake checks needed for some, published September 2011, [www.dbh.govt.nz/practice-advisory-13](http://www.dbh.govt.nz/practice-advisory-13)).

Develop revised criteria for stair support and protection of egress ways and incorporate them into the requirements for new designs and retrofits.

## 9.0 PRINCIPAL FINDINGS AND RECOMMENDATIONS

### Recommendation 7: Construction quality and compliance

#### (Priority B)

Review quality assurance processes in all phases of building design and construction, especially in light of the findings of these building investigations. Implement tighter controls and promote more designer involvement to ensure that design intentions are being achieved and that the work complies with the requirements of the approved design documents.

### Recommendation 8: Concrete quality

#### (Priority C)

Work with the concrete industry to review the in-situ strength of concrete achieved in a representative range of buildings around New Zealand and recommend any measures required to provide the necessary confidence that specified concrete strengths have been and will be achieved. Measures considered should include further strength testing of in-situ concrete in existing buildings and revisions to standards and procedures covering the manufacture, delivery, placement and curing of concrete in new buildings.

### Recommendation 9: Earthquake-prone buildings

#### (Priority A)

Promote and implement measures, and associated enforcements and incentives that would result in:

- improved definitions of earthquake-prone buildings and more effective implementation of strengthening measures, particularly for buildings likely to fail in a brittle manner.
- a stronger appreciation of the (private and public) value of good seismic performance of buildings and the benefits of improvement action
- effective and economic retrofit strategies that improve the earthquake safety of buildings
- adoption by territorial authorities of strongly active policies to reduce the risk posed by buildings of low earthquake resistance
- improved public awareness that buildings not classified as earthquake-prone under the Building Act 2004 but which fall short of 100%NBS may nevertheless collapse in a major earthquake.

## A

# Appendices

**Appendices (included in this report):**

<b>Appendix A</b>	<b>Panel members' biographies</b>	<b>100</b>
<b>Appendix B</b>	<b>Information obtained</b>	<b>103</b>
<b>Appendix C</b>	<b>Glossary of terms</b>	<b>107</b>

**Appendices (as separate volumes):**

<b>Appendix D</b>	<b>CTV Building consultant report</b>	<b>112</b>
<b>Appendix E</b>	<b>PGC Building consultant report</b>	<b>120</b>
<b>Appendix F</b>	<b>Hotel Grand Chancellor Building consultant report</b>	<b>123</b>
<b>Appendix G</b>	<b>Forsyth Barr Building consultant report</b>	<b>126</b>
<b>Appendix H</b>	<b>Contextual report</b>	<b>130</b>

**Note:**

The contents lists and, where applicable, addenda are bound into this volume.

Appendix

A

# Panel members' biographies

## **Sherwyn Williams (Chair)**

Sherwyn Williams has specialised in construction law for over 30 years, mainly in the areas of claims and dispute resolution. He was recommended by the Solicitor-General. He has acted for building and construction companies in respect of projects in New Zealand and overseas, and for a variety of owners, consultants, and industry organisations. Sherwyn has appeared as counsel in numerous court cases and arbitrations, and acts as an arbitrator and an adjudicator under the Construction Contracts Act 2002. He is a member of the Arbitrators' and Mediators' Institute's panel of arbitrators and its list of adjudicators, and a member of Building Disputes Tribunal's panel of principal arbitrators and adjudicators. He is the President of the Society of Construction Law New Zealand.

## **Nigel Priestley (Deputy Chair)**

Nigel Priestley is an eminent structural engineer, based in Christchurch. Nigel is uniquely qualified to provide both an academic and international perspective to the Panel. He has a PhD in Structural Engineering, is a former Professor of Structural Engineering at University of California, San Diego, has extensive international consulting experience and his work has been recognised with appointments and awards in Italy, United States, Argentina, Switzerland and New Zealand. He has published three books on seismic design, which have considerable local and international recognition, and has extensive experience in the assessment of structural failures in earthquakes (Newcastle Working Men's Club, Royal Palm Hotel in Guam, and various review panels post-Loma Prieta and Northridge earthquake).

## **Helen Anderson**

Helen Anderson is Deputy Chair of BRANZ, an independent director of DairyNZ and NIWA, and she is Chair of FulbrightNZ. She was Chief Executive of the Ministry of Research, Science and Technology for six years and before that was MoRST's Chief Scientific Adviser for more than five years. Helen has a PhD in seismology from the University of Cambridge. In 2009 Helen was elected as a Companion of the Royal Society of New Zealand. She is also a Companion of the Institution of Professional Engineers of New Zealand, and in 2010 she was appointed a Companion of The Queen's Service Order.

## **Marshall Cook**

Marshall has over 40 years' experience working within New Zealand, Australia, North America, Japan, Thailand and the Pacific Islands as an Architectural Consultant, Designer, Urban Planner and Educator. His involvement in a wide range of building types, construction methodology and international practices as well as a deep interest in material and structural performance has underpinned his professional practice and teaching career. He is currently an adjunct Professor of Design at Unitec, a member of the registered Architects Board and has served on the N.Z.I.A. National Council for several years. Recently awarded the N.Z.I.A. Gold Medal for services to architecture. He is also a Fellow of the Institute and recipient of the President's Award.

## **Peter Fehl**

Peter Fehl has spent most of his working life associated with the construction industry. The earlier years were spent on major civil engineering and commercial construction projects, both for himself and other major contractors, in various site and management positions. Peter has brought to the Panel expertise in the practices of the construction industry at the time these buildings were constructed.

**Clark Hyland**

Clark has twenty five years' experience in structural engineering. Half of that time has been in consulting engineering and the remainder for the New Zealand Heavy Engineering Research Association and Steel Construction New Zealand. He currently runs a consulting engineering company specialising in fatigue and earthquake engineering. He gained a PhD at the University of Auckland and has been Chairman of the New Zealand Steel Structures Standard Committee.

**Rob Jury**

Rob Jury graduated with a Masters in Civil Engineering from the University of Canterbury in 1978. A Technical Director in Beca's Wellington office, a Chartered Professional Engineer, and a Fellow of both the Institution of Professional Engineers and the New Zealand Society for Earthquake Engineering (NZSEE), Rob is one of New Zealand's most experienced earthquake engineers. He was a member of the committee that developed New Zealand's current earthquake loadings standard, and chairman of the NZSEE's Earthquake Risk Buildings study group that produced the current guidelines for the Assessment and Improvement of the Structural Performance of Buildings in Earthquakes. One of the many significant structures for which he has led the structural design is Auckland's Sky Tower.

**Peter Millar**

Peter Millar is a leading geotechnical engineer, and was Managing Director of Tonkin and Taylor (New Zealand's leading geotechnical consultancy which provided services to EQC on liquefaction following the 4 September 2010 earthquake). He has brought to the Panel expertise in geotechnical issues and foundation design.

**Stefano Pampanin**

Stefano Pampanin is Associate Professor in Structural Design & Earthquake Engineering and Chair of the Structures/Geotechnical Cluster at the Department of Civil and Natural Resources Engineering at the University of Canterbury. He received a Masters in Structural Engineering at University of California at San Diego and a PhD in Earthquake Engineering from the Technical University of Milan. His research and professional activities (Chartered Professional Engineer in Italy and New Zealand) have focused on the development and implementation of innovative solutions for the design of low-damage earthquake-resistant systems and the retrofit of existing structures. He is the author of more than 200 scientific publications and has received several national and international awards for his research and development achievements.

**George Skimming**

George Skimming is currently Director Special Projects at Wellington City Council. George has brought to the Panel expertise in the consenting practices at the time the buildings were constructed.

**Adam Thornton**

Adam Thornton is Managing Director of Dunning Thornton Consultants Ltd, a specialist structural/seismic engineering consultancy operating from Wellington, New Zealand. He is a Chartered Professional Engineer and a Fellow of the Institution of Professional Engineers of New Zealand. He has over 35 years' structural engineering design experience and has specialised in high-rise seismic design, the seismic retrofit of heritage and earthquake-prone buildings and the relocation of concrete and masonry buildings. He led the structural engineering team for the \$350m New Wellington Regional Hospital. Adam is a Past-President of the Association of Consulting Engineers of New Zealand and a past member of the IPENZ Practice Board. He is currently a board member (and Treasurer) of FIDIC – The International Federation of Consulting Engineers. He has represented engineers in a number of forums and has presented widely.

## Consulting engineers involved in specific building investigations

### **Beca**

Beca Carter Hollings & Ferner Ltd is part of the Beca group ([www.beca.com](http://www.beca.com)) which is a New Zealand-headquartered professional services organisation specialising in the design and management of projects. Beca is owned by its senior staff, and has more than 2500 employees who have operated in more than 70 countries from its three key market hubs of New Zealand, Australia and Singapore. Beca has a long history of participation in the development of design codes for the earthquake resilience of structures. Its earthquake engineering specialists have written and/or reviewed the codes for countries as diverse as Indonesia, Nepal, Papua New Guinea, Turkey and Romania, as well as contributing to New Zealand's codes over many years. Beca engineers have designed many of New Zealand's major office buildings, industrial structures and bridges.

### **Dunning Thornton Consultants**

Dunning Thornton Consultants [DTC] are a niche structural engineering consultancy specialising in complex structural and seismic projects. Founded in 1979 they have developed a reputation for innovative, award winning projects and the ability to solve complex problems. They have led the implementation of new, damage-limitation technologies in New Zealand and have become well known for their effective but sensitive seismic retrofit of heritage structures. They are respected by both clients and builders for their practical, solution-based approach to structural engineering. Based in Wellington they carry out work throughout the country and occasionally internationally.

### **Hyland Consultants Ltd/StructureSmith Limited**

Hyland Consultants Ltd is a specialist consulting engineering firm based in Auckland that focuses on fatigue and earthquake engineering of structures.

StructureSmith Ltd is a specialist structural engineering consultancy with specialist expertise in analysis of complex structures; earthquake engineering design and evaluation; assessment and strengthening of existing buildings; forensic engineering and problem solving; and building failure investigation.



# Information obtained

Information obtained in the course of investigation includes:

## General Information

Source	Information Obtained
<b>University of Canterbury</b>	<ul style="list-style-type: none"> <li>• Prelim Report April 2011 – Seismic Performance of Pre Cast Concrete Staircase Systems after 22 Feb earthquake (by Stefano Pampanin and Weng Yuen Kam)</li> <li>• Prelim Report March 2011 – The Seismic Performance of Reinforced Concrete Buildings Built 1930s – 1970s in the Christchurch CBD after the 22 Feb earthquake (by Stefano Pampanin et al)</li> <li>• 2011 PCEE Paper – Considerations on the seismic performance of pre-1970s RC buildings in the Christchurch CBD during the 4 Sept 10 earthquake: was that really a big one? (by Stefano Pampanin et al)</li> <li>• Prelim Report April 2011 – Pyne Gould Corp (PGC) Building 233 Cambridge Terrace post 22 Feb 2011 (by Stefano Pampanin and Weng Yuen Kam)</li> <li>• Lateral Spreading Assessments Feb 2011</li> </ul>
<b>Seismology/Earthquake Records</b>	<ul style="list-style-type: none"> <li>• GNS Science Earthquake Records 4 Sept 10</li> <li>• GNS Science Earthquake Records 26 Dec 10</li> <li>• GNS Science Earthquake Records 22 Feb 11</li> <li>• A New Seismic Hazard Model for New Zealand (by Mark W. Stirling, Graeme H. McVerry and Kelvin R Berryman)</li> <li>• 2003 PCEE Paper – From hazard maps to code spectra for New Zealand (by G. H. McVerry)</li> </ul>
<b>Ground Condition/ Borelogs</b>	<ul style="list-style-type: none"> <li>• Borelog information               <ul style="list-style-type: none"> <li>– Borelog Plan 3 – 20/4/60</li> <li>– Borelog Plan 4 – 20/4/60</li> <li>– Borelog Plan 5 – 20/4/60</li> <li>– Borelog – 233 Cambridge Tce #1</li> <li>– Borelog – 233 Cambridge Tce #2</li> <li>– Borelog – 208 Cambridge Tce</li> <li>– Borelog – 106 Gloucester St</li> <li>– Borelog – 746 Colombo St</li> <li>– Borelog – 253 Cambridge Tce</li> <li>– Borelog – Manchester St – Cambridge Tce – Bank of River</li> <li>– Borelog – 305 Manchester St Crown of Road</li> <li>– Borelogs near PGC &amp; Forsyth Barr</li> <li>– Borelogs – CBD</li> <li>– Borelogs – Medium zoom</li> <li>– Borelogs – Large zoom</li> </ul> </li> </ul>

**B** INFORMATION OBTAINED

**Building Specific Information Obtained**

Source	Information Obtained
<b>CTV Building</b>	<ul style="list-style-type: none"> <li>• Christchurch City Council Building Files, CTV Building 245 &amp; 249 Madras St. Post 4 Sept 10 files received as available</li> <li>• Complete structural drawings set</li> <li>• CTV Building 1990 Structural Report by engineers</li> <li>• CTV Sept 10 Earthquake Damage Report and photos by engineers</li> <li>• Forensic Site Examination and Materials Testing after 22 Feb earthquake <ul style="list-style-type: none"> <li>– Concrete Core Tests</li> <li>– Finger Beam Inspection</li> <li>– Reinforcing Steel Tests</li> <li>– Schmidt Hammer Column Properties</li> </ul> </li> <li>• ETABS Model</li> <li>• NTHA/ITHA</li> <li>• Geotechnical evaluation</li> <li>• Police photos</li> <li>• USAR photos</li> <li>• Interview with construction company personnel</li> <li>• Interview with witnesses of the CTV Building collapse in the 22 Feb 2011 aftershock</li> <li>• Interviews with USAR Engineers</li> <li>• CTV Sept 10 Earthquake Damage Report and photos by engineers</li> <li>• Public evidence <ul style="list-style-type: none"> <li>– Accounts of the state of the building prior to 22 Feb</li> <li>– Witness accounts of building collapse</li> <li>– Tradespeople who worked on the building</li> <li>– Photos received <ul style="list-style-type: none"> <li>- Prior to 22 Feb</li> <li>- Showing damage to building following Sep 10 earthquake</li> <li>- Immediately following 22 Feb earthquake showing collapsed building</li> <li>- During construction in 1987</li> </ul> </li> </ul> </li> </ul>

## Building Specific Information Obtained

Source	Information Obtained
<b>PGC Building</b>	<ul style="list-style-type: none"> <li>• Christchurch City Council Building Files, PGC Building 233 Cambridge Tce. Post 4 Sept 10 files received as available</li> <li>• Complete structural drawings set</li> <li>• PGC 1997 Seismic Evaluation of Building by engineers</li> <li>• PGC 2007/08 Alterations and Options by engineers</li> <li>• Prelim Report April 2011 – Pyne Gould Corp (PGC) Building 233 Cambridge Terrace post 22 Feb 2011 (by Stefano Pampanin and Weng Yuen Kam)</li> <li>• Police photos</li> <li>• USAR photos</li> <li>• Forensic Site Examination and Materials Testing after 22 Feb 11 aftershock: <ul style="list-style-type: none"> <li>– Concrete Core Tests</li> <li>– Reinforcing Steel Tests</li> </ul> </li> <li>• Public evidence <ul style="list-style-type: none"> <li>– Accounts of the state of the building prior to 22 Feb 11</li> <li>– Witness accounts of building collapse</li> <li>– Tradespeople who worked on the building</li> <li>– Photos received <ul style="list-style-type: none"> <li>- Prior to 22 Feb 11</li> <li>- Showing damage to buildings following 4 Sep 10 earthquake</li> <li>- Immediately following 22 Feb 11 aftershock showing collapsed building</li> <li>- During construction in 1987</li> </ul> </li> </ul> </li> <li>• Interviews with PGC Building tenants</li> <li>• Interview with PGC Building owner</li> <li>• Interviews with USAR engineers</li> </ul>

**B** INFORMATION OBTAINED

**Building Specific Information Obtained**

Source	Information Obtained
<b>Hotel Grand Chancellor Building</b>	<ul style="list-style-type: none"> <li>• Christchurch City Council Building Files, 145 Cashel St and 161 Cashel St. Post 4 Sept 10 files as available also received for 161 Cashel St</li> <li>• Complete structural drawings set, original design and alterations</li> <li>• Seismic Inspection Report by engineers after 4 Sep 10 earthquake</li> <li>• Hotel Grand Chancellor 1988 Development Report by engineers</li> <li>• USAR photos</li> <li>• Post 4 Sept 10 Earthquake Damage Report by engineers</li> <li>• Post 26 Dec 10 Earthquake Damage Report by engineers</li> <li>• Post 22 Feb 11 Earthquake Damage Report by engineers</li> <li>• Public evidence <ul style="list-style-type: none"> <li>– Accounts of the state of the building prior to 22 Feb 11</li> <li>– Photos received <ul style="list-style-type: none"> <li>- Prior to 22 Feb 11</li> <li>- Showing damage to building following 4 Sep 10 earthquake</li> <li>- Showing damage to building following 22 Feb 11 earthquake</li> </ul> </li> </ul> </li> <li>• Interview with USAR engineers</li> </ul>
<b>Forsyth Barr Building</b>	<ul style="list-style-type: none"> <li>• Christchurch City Council Building Files, Forsyth Barr Building 764 Colombo St and 114 Armagh St. Post 4 Sept 10 files received for 764 Colombo St as available</li> <li>• Structural drawing set</li> <li>• Forsyth Barr Post Sept 10 Earthquake and Repair Reports by engineers</li> <li>• Forensic Site Examination and Materials Testing after 22 Feb 11 aftershock: <ul style="list-style-type: none"> <li>– Concrete Core Tests</li> <li>– Reinforcing Steel Tests</li> </ul> </li> <li>• USAR photos</li> <li>• Interview with Forsyth Barr Building owner</li> <li>• Interview with USAR engineers</li> <li>• Interviews with Forsyth Barr Building tenants</li> <li>• Public evidence <ul style="list-style-type: none"> <li>– Accounts of the state of the building prior to 22 Feb 11</li> <li>– Photos received <ul style="list-style-type: none"> <li>- Prior to 22 Feb 11</li> <li>- Showing damage to building following 4 Sep 10 earthquake</li> </ul> </li> </ul> </li> <li>• Showing damage to building following 22 Feb 11 aftershock</li> </ul>

**Other Information**

Source	Information Obtained
<b>Media</b>	<ul style="list-style-type: none"> <li>• Daily Media Monitor Reports</li> <li>• Footage from TVNZ</li> <li>• Broadcast summaries</li> </ul>



# Glossary of terms

**Acceleration response spectra** – Plot (graph) showing peak building accelerations relative to the fundamental period of the building.

**Axial loads** – A pure tension or compression load acting along the long axis of a structural member (eg a beam or column).

**Axial capacity** – Maximum *axial load* that can be carried without failure.

**Base shear** – Base shear is an estimate of the maximum expected lateral force that will occur due to seismic ground motion at the base of a structure. [The base shear is a summation of the individual shears occurring at each floor level and is determined from a number of factors including the weight of the building, the site's earthquake intensity, the ground conditions, and the building's structural characteristics.]

**Biaxial bending** – Bending of a structural member about two perpendicular axes at the same time.

**Cantilever structure** – A structure that is supported at one end only and that support provides full fixity.

**Capacity** – Overall ability of a structure or structural member to withstand the imposed demand.

**Capacity design** – A design process which limits forces in some structural members in order to protect others. Eg the weak beam /strong column approach protects columns.

**Catenary** – A curve formed by a chain or rope hanging freely from two points.

**Centre of rigidity** – If load is applied at a building's centre of rigidity, the building will not rotate or twist.

**Compression failure** – Failure of a structural member that occurs when its *axial capacity* in compression is exceeded.

**Confined concrete** – Concrete which is restrained by transverse reinforcement (ie reinforcement at right angles to the principal reinforcement eg stirrups around a column or beam's longitudinal reinforcement) from bursting outwards (like hoops on a barrel).

**Critical capacity ratios** – The ratio of the building's or structural member's capacity to the *demand* placed on it, at which failure occurs.

**Damped horizontal acceleration** – Horizontal accelerations in a building subjected to the building's *damping*.

**Damping** – Damping is the process by which energy in a vibrating system is absorbed causing a decaying trend in the system's response. Damping in buildings is caused by a variety of factors including internal material energy dissipation effects, friction between components and drag.

**Dead load** – The self weight of the building exclusive of any applied load.

**Deflection** – *Displacement* measured from an at-rest or agreed starting position.

**Deformation** – Deformation in a structural or other member is a change in the original shape of the member. Deformation in a building occurs when it deflects or otherwise reacts to applied load.

**Demand** – A generic term to describe structural actions caused by gravity, wind, earthquake and snow, acting on a structure.

**Design capacity ratios** – The ratio of estimated (load) *capacity* to the (load) demand as used for design purposes.

**Design Features Report** – A report that summarises key information about the design intentions, material properties, structural configuration and other important characteristics of a building.

## C GLOSSARY OF TERMS

**Design (or response) spectra** – Graphical relationship of maximum response of buildings to dynamic motion or forces. The most usual measures of response are maximum *displacement*, velocity and acceleration relative to the natural period of vibration of the building.

**Diaphragm** – A structural element that transmits in-plane forces (diaphragm forces) to and between lateral force resisting elements. In buildings, floors usually act as, and are occasionally called, diaphragms.

**Displacement** – Displacement is the difference between the initial position of a reference point and any later position. The amount any point affected by an earthquake has moved from where it was before the earthquake.

**Displacement response spectra** – Plot (graph) showing peak building *displacements* of the centre of gravity of a building in response to a specified ground motion.

**Double-tee** – A structural member, normally of pre-cast concrete and used horizontally, that has the configuration of two adjacent capital 'Ts'.

**Drag bars** – Structural members that transfer lateral loads from a floor slab to the building's seismic resisting elements eg walls.

**Ductile** – See '*Ductility*'.

**Ductility** – The ability of the structure or element to undergo repeated and reversing *inelastic deflections* while maintaining a substantial proportion of its initial load carrying capacity. The benefits of ductile design are that the building can be designed for lateral forces less than those required for elastic response. Further, the building is likely to remain standing or at least not suffer a brittle and sudden failure if it is subjected to an earthquake larger than the design earthquake.

**Dynamic** – Things that change with time eg dynamic loads.

**Earthquake** – A term used to describe both sudden slip on a fault and the resulting ground shaking and radiated seismic energy caused by the slip.

**Earthquake-prone** – The definition of an earthquake-prone building is given in section 122 of the Building Act 2004. In summary, an earthquake-prone building is one that if assessed against current (new) building standards (NBS), would be assessed as not sustaining more than 33% of the minimum design actions for strength and ductility for the ultimate limit state.

**Earthquake risk buildings** – A building is assessed as an earthquake risk building if when assessed against the minimum requirements in current buildings standards, it sustains between 33% and 67% of the minimum design actions for strength and ductility for the ultimate limit state.

**Eccentricity** – A measure of the distance from the point of load application to the *centre of rigidity*. The greater the eccentricity, the greater the rotation.

**Egress** – Way out or exit.

**Elastic** – Structural behaviour where an element or part springs back to its initial position when load is removed (no energy is absorbed in the process).

**Epicentre** – The epicentre is the point on the Earth's surface vertically above the focus point in the crust where a seismic rupture begins.

**Fixity** – Measure of the amount of rotation in a structural member allowed at the support point. A cantilever which by definition has full fixity has no rotation at the face of its support. A pin (or roller or hinged) support provides no fixity and allows the structural member to rotate freely at the face of the support under applied load.

**Flexure** – Bending under load.

**Flexural cracking** – Cracking as a result of *flexure*.

## C

## GLOSSARY OF TERMS

**Flexural-torsional buckling** – Failure of a structural member resulting from simultaneous torsion (twisting) and *flexure* (bending).

**Flexible soils** – Soils which deflect more than usual under load.

**Floor diaphragms** – Broad horizontal structural floor members (eg concrete slabs) that carry horizontal load to the building's seismic resisting elements (eg frame or shear wall).

**Geotechnical** – Referring to the use of scientific methods and engineering principles, to acquire, interpret, and apply knowledge of earth materials for solving engineering problems.

**Ground motion** – The movement of the Earth's surface from earthquakes. Ground motion is produced by waves that are generated by a sudden slip on a fault and travel through the earth and along its surface.

**Hinge zone** – That portion of a structural member which undergoes *inelastic deformations*.

**Hollow-core** – A term that refers to a pre-cast concrete slab unit that has hollow cores along its length to reduce its weight.

**Horizontal shear** – *Shear* in a horizontal direction.

**Inelastic** – The member or element goes beyond its elastic limit (it does not return to initial position and energy is absorbed).

**In-plane** – Along the face of, or parallel to, the structural member under consideration.

**In-situ concrete** – Concrete poured on site.

**Inter-storey drift** – Horizontal displacement of a floor relative to the floor immediately below.

**Kilopascals (kPa)** – Measurement of pressure being equal to one thousand Pascals. A Pascal being the pressure resulting from the force of one Newton applied over an area of one square metre.

**Lap zone** – Zone where reinforcement is overlapped so as to maintain its structural continuity.

**Lateral displacement** – Movement in a sideways or horizontal direction.

**Lateral resilience** – Ability of a structure to withstand lateral actions.

**Lateral spreading** – Horizontal movement of the ground as a result of *liquefaction*.

**Liquefaction** – Loss of resistance to shear stress of a water-saturated, silty-sandy soil as a consequence of earth shaking, to the extent that the ground behaves as a liquid rather than a solid.

**Liquefaction ejecta** – Soil that has been pushed up and ejected at the ground surface as a result of liquefaction.

**Linear (refer to Elastic)**

**Linear static analysis** – Another term for 'equivalent static analysis'.

**Live load** – The applied load or weight borne by a structure.

**Magnitude** – A measure of the energy released by an earthquake at its source. Magnitude is commonly determined from the shaking recorded on a seismograph. Each unit of magnitude on the scale represents a substantial increase in energy, for example a Magnitude 5 releases 30 times more energy than a Magnitude 4.

**Masonry infill wall** – Infill panel between structural members made of masonry construction.

**Mercalli Scale** – A 10-degree scale that measures *earthquake intensity* by examining its effects on the Earth's surface, humans, objects of nature, and man-made structures. Mercalli, an Italian seismologist, developed the scale in the early 20th century. Since that time it has been modified several times, and is known today as the *Modified Mercalli Scale*. Referred to as MM or MMI (Intensity).

## C GLOSSARY OF TERMS

**Modal analysis** – Analysis of the building that considers and combines the various modes of vibration to determine the building's total response.

**Moment demands** – The flexural demands on a structural member.

**Moment frame** – A structural frame which resists applied loads, primarily in bending or *flexure*.

**Moment-resisting** – Able to resist the *moment demands* placed on it.

**Non-ductile** – Prone to sudden or brittle failure.

**Non-linear** – Describes behaviour beyond *linear* (or *elastic*).

**NTHA/ITHA** – Modelling techniques that measure the response of a building in a time history.

**Out-of-plane** – At right angles to the face of, or perpendicular to, the structural member under consideration.

**P-delta effects** – Destabilizing effects due to (significant) horizontal *displacement* of the centre of gravity of a structure (eg from an earthquake). When a structure is displaced, P-delta effects reduce the resistance of the structure to further *displacement* in the same direction. P-delta effects are important considerations in *ductile* (flexible) structures.

**Performance-based design** – Design that meets nominated building performance criteria.

**Planar** – In the plane of, or parallel to, the structural member.

**Pounding** – Effect of two objects (buildings) impacting against or striking each other.

**Pre-cast concrete** – Concrete poured at a location remote from the building site and later transported to and placed on the site.

**Response spectra** – The peak accelerations (or displacements) with the period of vibration of structures due to an earthquake or a design earthquake.

**Retrofitting** – Reinforcement or strengthening of existing structures to become more resistant and resilient to earthquakes.

**Return period** – The average time in years between earthquakes of a given magnitude on a fault or in a locality. The magnitude of the earthquake and the associated actions are assumed to increase with the return period. Hence the design actions for an earthquake with a return period of 2,500 years is assumed to be 1.5 (or 1.8) times the corresponding values for an earthquake with a return period of 500 years.

**Sand boil** – A sand boil is sand and water that come out onto the ground surface during an earthquake as a result of *liquefaction*.

**Section capacities** – The limiting (maximum) actions (bending, *shear* and *axial load*) that a structural member (eg beam or column) can withstand without failure.

**Seismic frame** – A frame, comprising columns and beams, that contributes to the building's lateral resistance enabling it to withstand earthquake actions.

**Seismic gap** – A separation between buildings or building elements which allows them to move during earthquakes.

**Seismic response spectra** – See *Response spectra*.

**Seismicity** – Refers to the geographic and historical distribution of earthquakes and their effects.

**Shear** – A force applied at right angles to a main axis of a building or structural member.

**Shear wall** – A wall that contributes to the building's lateral resistance enabling it to withstand earthquake actions.



## C

## GLOSSARY OF TERMS

**Shear wave velocity** – The velocity of a shear wave (being one type of ground wave generated by an earthquake). Shear waves are transverse waves with particle motion perpendicular to the direction of wave propagation. Shear waves can be destructive because of their larger amplitudes.

**Spalling** – The loss of cover concrete, being the concrete between the external face of a structural member (eg beam or column) and the main reinforcing steel.

**Spandrel panels** – Panels on the external face of the building. Spandrel panels normally extend from ceiling level on one floor to window sill height on the floor above. Spandrel panels are often used to provide fire separation between floors but can also have a structural function or comprise part of the building's cladding.

**Tensile** – Relates to tension in a structural member.

**Tensile failure** – Failure of a structural member as a result of tension.

**Torsion** – Twisting of a structural member or building as occurs when loads are applied other than through the member or building's centre of rigidity.

**Transfer beams** – Structural members that transfer lateral loads at floor slab level to the building's seismic resisting elements (eg to its seismic frame or shear wall).

**Unreinforced masonry (URM) buildings** – May consist of brick buildings, or buildings built using stone masonry.

**Vertical acceleration** – Earthquake acceleration measured in the vertical direction.

**Wall fins** – Structural members at right angles to a wall to provide lateral stability.

**Yielding** – Deforming under constant load.

Appendix

D

# CTV Building consultant report

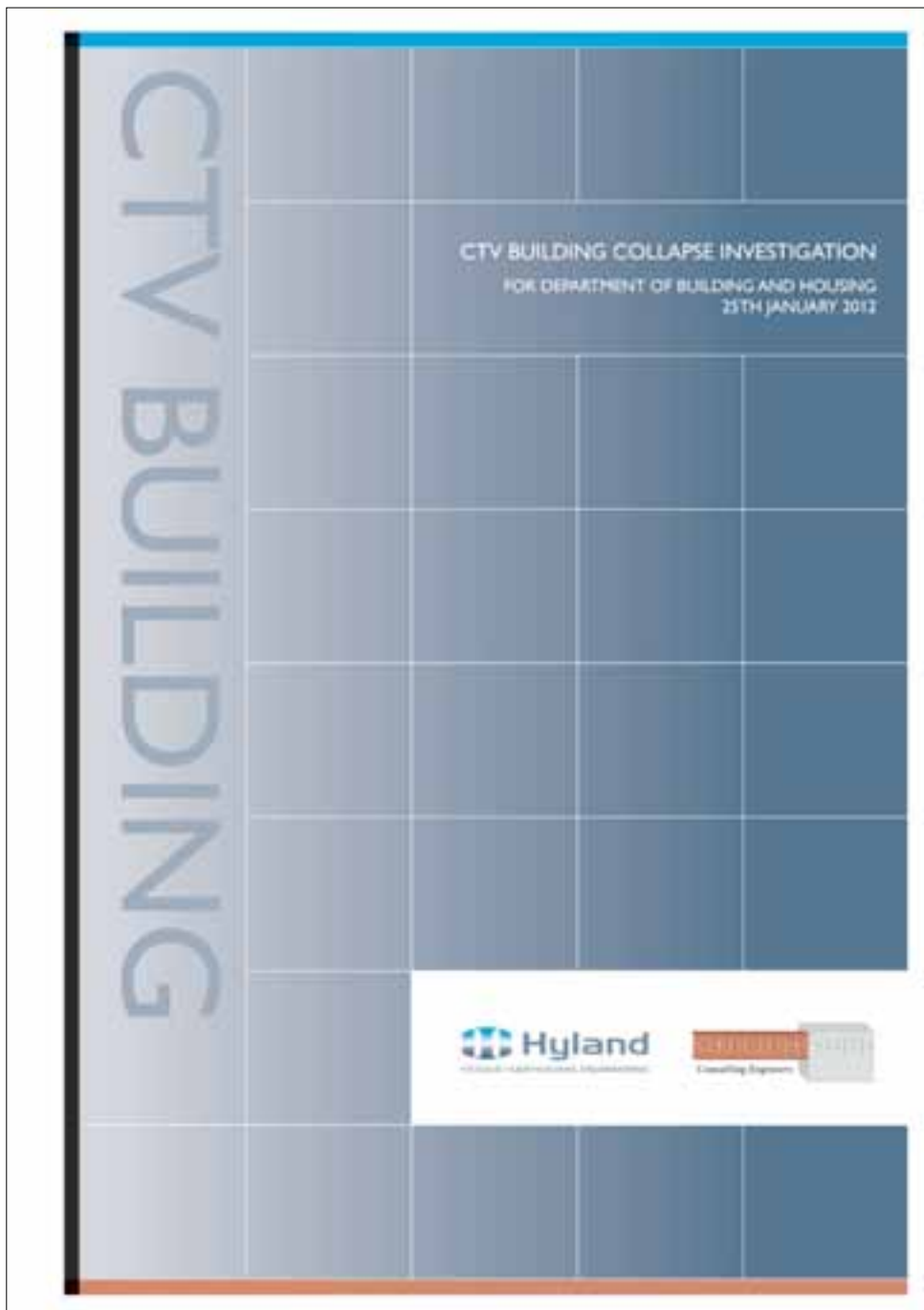

## CTV BUILDING COLLAPSE REPORT

## TABLE OF CONTENTS

Table of Tables	xiii
Table of Figures	xv
Glossary	xxv
<b>Executive Summary</b>	<b>1</b>
Overview	1
Investigation	3
Building Description	4
Structural Modifications	5
Earthquake and Other Effects Prior to 22 February	6
4 September 2010 Earthquake	6
Demolition of Neighbouring Building	7
26 December 2010 Boxing Day Aftershock	7
Collapse On 22 February 2011	7
Eye-witness accounts	7
Examination of collapsed building	8
Inspections and Photographs	8
Site Examination and Materials Testing	8
Collapse Evaluation	9
Approach and Limitations	9
Areas of Different Opinion	12
Soils and Foundations	13
Ground Shaking Records for Analysis	13
Critical Vulnerabilities	13
Columns	13
Spandrel Panels	15
Irregularities / Lack of Symmetry	16
Diaphragm Connection	17
Collapse initiation examined	18
Critical Column Identification	18
Key data and results	19
Elastic Response Spectra Analysis	19
Seismic Detailing Requirements Check	20
Column F2 Level 3 – Demand versus Capacity	21
Effect of Vertical Acceleration	24
Effect of Reduced Concrete Strength	25
Drift Demand Capacity Comparison	25
Possible Collapse Scenario	26
Compliance / Standards Issues	27
Building Inter-storey Drift Limits	27
Drift Capacity of Columns	27

## D CTV BUILDING CONSULTANT REPORT

### CTV BUILDING COLLAPSE REPORT

#### TABLE OF CONTENTS

continued

Minimum Column Shear Reinforcement	28
Spandrel Panel Separation	28
Plan Asymmetry and Vertical Irregularity	28
Wall on Line A	29
Diaphragm Connection	29
Documentation	29
Percentage New Building Standard Assessment	30
Geotechnical Compliance	30
Construction Issues	30
Construction Supervision and Monitoring	30
Conclusions	30
Recommendations	32
Irregular Structures	32
Non-ductile Columns	32
Pre-cast Concrete Panels	32
Diaphragm Connections	32
Design and Construction Quality	32
<b>1 Introduction</b>	<b>39</b>
Objectives and Scope	39
Terms of Reference	39
Matters for Investigation	39
Matters Outside the Scope of the Investigation	40
<b>2 Investigation Methodology</b>	<b>41</b>
Information Gathering	41
Witness Interviews	41
Site Examination and Materials Testing	41
Structural Analyses	42
Determination of Collapse Sequence	42
<b>3 Description of the CTV Building</b>	<b>43</b>
CTV Building Location	43
Outline Description, Key Features and Photos	43
Procurement Process	45
Site Investigations (Soils, Seismology)	45
Design, Drawings and Specifications	46
Variations During Construction	46
Remedial Work After Construction	46
Post-occupancy Tenancy Alterations	47
<b>4 Earthquake and Other Effects Prior to 22 February 2011</b>	<b>49</b>
Effects of 4 September 2010 Earthquake	49
Effects of 26 December 2010 Aftershock	56
Effects of Demolition of Neighbouring Building	58
<b>5 Collapse on 22 February 2011</b>	<b>59</b>
<b>6 Eyewitness Accounts</b>	<b>65</b>

**D CTV BUILDING CONSULTANT REPORT**

## CTV BUILDING COLLAPSE REPORT

## TABLE OF CONTENTS

continued

Introduction	65
Interpretation of Eyewitness Observations	65
Common Observations About The February Aftershock and Collapse	66
<b>7 Examination of Collapsed Building</b>	<b>69</b>
Introduction	69
Immediate Post-Collapse Condition Photos	69
Debris Removal Photos	70
Introduction	70
Observations	70
Conclusions	75
Physical Examination	76
Introduction	76
Madras Street Site Examination	76
Burwood Eco Landfill Columns	80
Materials Sampling and Testing	82
Reinforcing Steel	82
Concrete Testing and Statistical Assessment	82
Allowance for Strength Aging Effect of Concrete	82
Wall Concrete	83
Slab Concrete	83
Beam Concrete	83
Column Concrete	83
<b>8 Collapse Scenario Evaluation</b>	<b>87</b>
Introduction	87
Overview	88
Critical Demand/Capacity Issues	89
Demand Issues	90
Analysis Methods and Limitations	90
Gravity Loads	90
Earthquake Response of Structure	90
Capacity Issues	91
Introduction	91
Column Drift Capacity	91
Diaphragm Connection Capacities	93
Beam-column joint Capacities	93
Line A Wall Strength / Stiffness Capacities	93
Other Influences on Structural Capacity	94
Collapse Initiators examined	94
Critical Column Identification	95
Key data and results	96
Elastic Response Spectra Analysis	96
Seismic Detailing Requirements Check	97
Column F2 Level 3 – Demand versus Capacity	98

**D CTV BUILDING CONSULTANT REPORT**

## CTV BUILDING COLLAPSE REPORT

## TABLE OF CONTENTS

continued

Effect of Vertical Acceleration	100
Drift Demand Capacity Comparison	101
Possible Collapse Scenario	102
The Four Scenarios	103
Preferred Collapse Scenario	103
Scenario 1: Line F or I Column Collapse Initiation	103
Scenario 2: Isolated Line 2 or 3 Column Collapse Initiation	105
Scenario 3: Level 2 and 3 Diaphragm Detachment from North Core	106
Scenario 4: North Core Line D or DE Drag Bar Detachment at Level 4 and 5	107
<b>9 Design, Construction and Standards Issues</b>	<b>109</b>
Introduction	109
Design Issues	109
Building Inter-storey Drift Limits	109
Drift Capacity of Columns	109
Minimum Shear Reinforcing of Columns	110
Spandrel Panel Separation	110
Beam-column joints	112
Plan Asymmetry and Vertical Irregularity	112
Wall on Line A	112
Diaphragm Connection	113
Robustness	113
Documentation	114
Percentage New Building Standard Assessment	114
Construction Issues	115
Concrete Strength	115
Construction Joints	116
Bent -up Bars	116
Separation of Elements	116
Construction Supervision and Monitoring	116
Standards and Code Issues	117
Introduction	117
Design and Construction Documentation	117
Non-ductile Columns	118
Vertical Acceleration Effects	119
Concrete Strength Effects	119
Analysis and Design of Irregular Structures	119
Diaphragm Connections	119
<b>10 Conclusions</b>	<b>121</b>
<b>11 Recommendations</b>	<b>123</b>
Irregular Structures	123
Non-ductile Columns	123
Pre-cast Concrete Panels	123

## D CTV BUILDING CONSULTANT REPORT

### CTV BUILDING COLLAPSE REPORT

#### TABLE OF CONTENTS

continued

Diaphragm Connections	123
Design and Construction Quality	123
<b>12 References</b>	<b>125</b>
<b>Appendix A – Eyewitness Summaries</b>	<b>127</b>
<b>Interviews with Eyewitnesses</b>	<b>127</b>
Eyewitness Locations	127
Eyewitnesses inside the CTV Building	127
Eyewitnesses outside the CTV Building	127
<b>Eyewitness Location Map</b>	<b>129</b>
<b>Interview Summaries</b>	<b>133</b>
Eyewitness 1	133
Eyewitness 2	134
Eyewitness 3	135
Eyewitness 4	136
Eyewitness 5	138
Eyewitness 6	139
Eyewitness 7	140
Eyewitness 8	142
Eyewitness 9	143
Eyewitnesses 10 & 11	146
Eyewitness 12 & 13	148
Eyewitness 14	150
Eyewitness 15	151
Eyewitness 16	152
<b>Appendix B – Photos of Collapsed Building</b>	<b>155</b>
<b>B.1 IMMEDIATELY After Collapse</b>	<b>155</b>
West Wall (Line A)	156
Cashel St (South, Line I)	157
Madras Street (East, Line F)	159
<b>B.2 Debris Removal Sequence</b>	<b>161</b>
Overhead Views	161
<b>Appendix C - Summary of Site Examination and Materials Testing Results</b>	<b>179</b>
Introduction	179
Prolled Metal Deck and Concrete Suspended Slab	179
Pre-cast Concrete Shell Beams	179
400 mm Diameter Columns	181
Internal Pre-cast log Beams on Line 2 and 3	181
External Pre-cast Log Beam on Line 1 and 4	181
Line 1 South Wall	183
Level 1 to 2 (Item E1)	183
Level 2 to 3 (Item E2)	184
Level 4 to 5 (Item E4)	184

## D CTV BUILDING CONSULTANT REPORT

### CTV BUILDING COLLAPSE REPORT

#### TABLE OF CONTENTS

continued

Level 5 to 6 (Item ES)	184
Level 6 to Roof (Item ESA)	185
North Core Walls	187
Slab and Beam Remnants on Line 4 of North Core	188
Level 6 Slab	188
Level 5 Slab	188
Level 4 Slab	188
Level 3 Slab	188
Level 2 Slab	188
Slab Diaphragm Connections to North Core Wing Walls on Grid D and D/E	190
Level 2 Connection of Slab to Walls	190
Level 3 Connection of Slab to Walls	190
Level 4 Connection of Slab to Walls	190
Level 5 and 6 Connection of Slab to Walls	190
Connection of Column D/E 4 to North Core at Level 7	192
Levels and Positional Survey	192
Reinforcing Steel Properties	193
Concrete Properties	193
Suspended Slab Concrete Properties	194
South Wall and North Core Concrete Properties	194
Column Concrete Properties Summary	195
<b>Appendix D - Non-linear Time History Analysis</b>	<b>199</b>
Introduction	199
Analysis Overview	199
Key Assumptions	201
nonlinear Static Pushover Analysis	204
Structural Models and Earthquake Records	206
Base Shear	208
Storey Drifts	208
Effects of Masonry Infill Walls	212
Inelastic Demands for the September Earthquake	214
Assessment of Floor Diaphragm Connections	215
Vertical Earthquake Effects	217
Assessment of Critical Columns	220
General	220
Potential Failure Criteria and Critical Columns	221
Critical Column Identification	221
Analysis Results	223
Figure 139 for the column at Grid D2 at Level 3:	225
Figure 140 and Figure 141 for the Column at Grid F2 at Level 3:	225
Assessment of Beam-Column Joints	228
Conclusions	228
<b>Appendix E - Elastic Response Spectra Analysis</b>	<b>231</b>
Earthquake and Aftershock Records	231



## D CTV BUILDING CONSULTANT REPORT

### CTV BUILDING COLLAPSE REPORT

#### TABLE OF CONTENTS

continued

Strong Motion Recordings	231
Averaged Resultant Response Spectra	233
Response Spectra and NZS 4203:1984 Design Spectra	234
ERSA Modelling	236
Introduction	236
ERSA Computer Modelling Assumptions	236
Modelling of Line A Masonry Infill Wall	239
ERSA Results	245
Irregularity and Torsional Response	245
South Wall	249
Line A Masonry In-Fill Wall Shear	250
South Wall and North Core Flexural Action to Capacity Ratio	250
Flexural Demands vs Capacity of South Wall	250
Flexural Demands vs Capacity of Line 5 Wall	251
Limitations of the NZS 4203:1984 and Current ERSA Provisions	252
<b>Appendix F - Displacement Compatibility Analysis to Standards</b>	<b>253</b>
Introduction	253
Method	253
Check on Adequacy of Non-Seismic Detailing in Columns	255
Adequacy of primary frame stiffness to NZS 4203:1984	259
Adequacy of Drift Caps/City for 2010 Standards	259
Comparative Demands of Earthquakes	259
Effect of Vertical Acceleration	261
Effect of Concrete Strength on Drift Capacity	261
Summary	261
<b>Appendix G - Diaphragm Failure Analysis at North Core</b>	<b>263</b>
Floor Diaphragm Connections to the North Core Walls	265
<b>Appendix H- Geotechnical Report Summary</b>	<b>273</b>
<b>Appendix I - Design and Construction Standards and Specification Clauses</b>	<b>275</b>
Plan and Vertical Irregularity	275
Inter-storey Drift Limits	275
Separation of Secondary Structural Elements	276
Design of Reinforced Concrete Secondary Elements	276
Designation of Group 1 and 2 Secondary Elements	276
Group 1 Separated Elements	276
Group 2 Non-separated Secondary Elements	277
Construction Monitoring and Inspection Requirements	277
Building Permit Conditions ( Application No. 1747)	277
Code of Practice for the Design of Concrete Structures NZS3101:1982	278
Specification for Concrete Construction NZS 3109: 1980	278
<b>Appendix J - Drawings and Specification</b>	<b>281</b>
Drawings	282
Concrete and Reinforcing Steel Specification	297

Appendix

E

# PGC Building consultant report

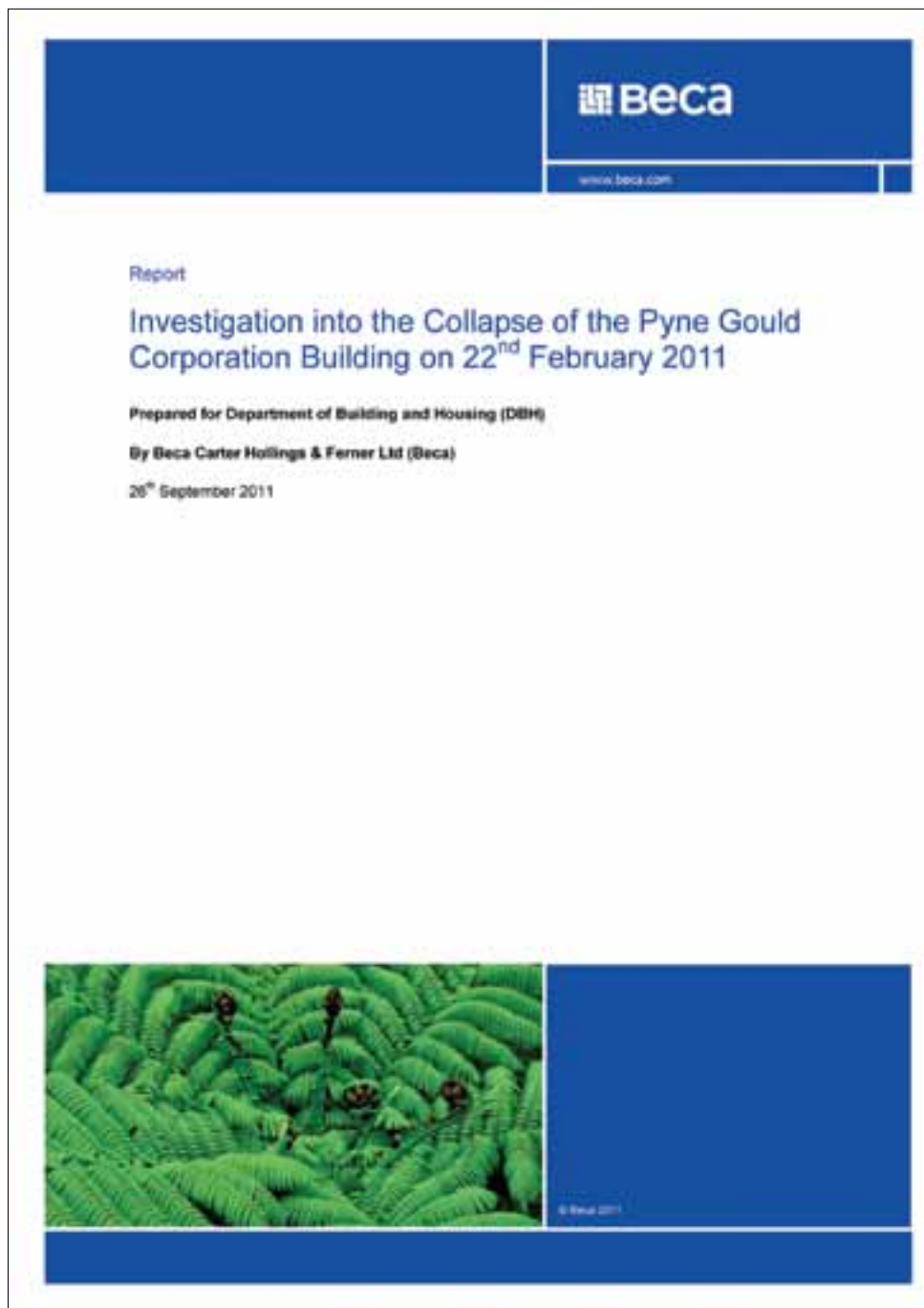

Investigation into the Collapse of the Fyne Guild Corporation Building on 22nd February 2011

## Table of Contents

<b>Executive Summary</b> .....	<b>1</b>
<b>1 Introduction</b> .....	<b>4</b>
<b>2 Objective and Scope</b> .....	<b>5</b>
<b>3 Approach/Methodology</b> .....	<b>6</b>
3.1 General .....	6
3.2 Information Gathering .....	7
3.3 Reporting .....	7
<b>4 Building Description</b> .....	<b>8</b>
4.1 Outline/Summary .....	8
4.2 Site Investigations (Soils, Seismology) .....	11
4.3 Design, Drawings and Specifications .....	16
4.4 Variations during Construction .....	16
4.5 Post-Occupancy Alterations .....	16
4.6 Effects of Time (Settlement, Corrosion, etc.) .....	17
<b>5 Earthquake Effects on Site and Building</b> .....	<b>19</b>
5.1 Earthquake Records .....	19
5.2 4 <sup>th</sup> September 2010 and Aftershock Sequence .....	22
5.3 Boxing Day, 26 <sup>th</sup> December 2010 .....	26
<b>6 Effects of 22<sup>nd</sup> February 2011 Earthquake at PGC Site</b> .....	<b>29</b>
<b>7 Collapse Description</b> .....	<b>33</b>
<b>8 Evaluation/Analysis</b> .....	<b>37</b>
8.1 Structure Condition/Capacity prior to Collapse .....	37
8.2 Effects of Earthquake on Site and Structure .....	38
<b>9 Consultant Evaluation of Collapse and Possible Reasons for it</b> .....	<b>39</b>
<b>10 Conclusions</b> .....	<b>43</b>
10.1 Reasons for Collapse .....	43
10.2 Pre-Warning of Collapse .....	44
10.3 Other Factors .....	44
<b>11 Recommendations</b> .....	<b>45</b>
11.1 Recommendations to DBH in Relation to Building Investigation, Design, Construction or Approvals .....	45
11.2 Other Recommendations .....	45
<b>12 References</b> .....	<b>46</b>

Investigation into the Collapse of the Pire Gault Corporation Building on 22nd February 2011

## Appendices

### A1 Building Data

- A1.1 Original Structural Drawings
- A1.2 Wall Materials Test Reports
- A1.3 Model Representations of the Building

### A2 Post-Occupancy Work

- A2.1 1997 Structural Change Drawings

### A3 Reports on Structure

- A3.1 April 1997 Analysis Report

### A4 Structural Analyses

- A4.1 Introduction
- A4.2 Computer Software
- A4.3 Computer Models
- A4.4 Input Loading
- A4.5 Analyses
- A4.6 Results
- A4.7 Comparison between Push-over Analysis Results and Spectra from 4<sup>th</sup> Sept 2010, Boxing Day 2010 and 22<sup>nd</sup> Feb 2011 Earthquakes

### A5 Assessment of Seismic Performance

- A5.1 Introduction
- A5.2 Overall Capacity
- A5.3 Shear Strength of the Shear-Core
- A5.4 Shear Strength of the Columns
- A5.5 Shear strength of the Beam/Column Joint Regions
- A5.6 Strength of Slab to Shear-Core Connection
- A5.7 Foundation Uplift
- A5.8 Buckling of Shear-core Wall Flanges

### A6 Site Data

- A6.1 Site Survey
- A6.2 Geotechnical Report

Appendix

F

# Hotel Grand Chancellor Building consultant report

**Christchurch Earthquake  
CBD Building Performance Technical Investigation**

**Report on the Structural Performance  
of the  
Hotel Grand Chancellor  
in the  
Earthquake of 22 February 2011**

Prepared By:  
Dunning Thornton Consultants Ltd

For:  
The Department of Building & Housing

Final: 26 September 2011



6888 Ch-ch EQK CBD Building Performance Investigation  
Hotel Grand Chancellor - Final 26 Sept 2011  
Page 1

## CONTENTS

<b>Executive Summary.....</b>	<b>4</b>
<b>1. Introduction .....</b>	<b>5</b>
<b>2. Objective and Scope.....</b>	<b>6</b>
<b>3. Approach / Methodology.....</b>	<b>6</b>
<b>4. Description and History.....</b>	<b>7</b>
4.1. General	
4.2. Description of Structure	
4.2.1. Lower Tower	
4.2.2. Upper Tower	
4.2.3. Wall D5-6	
4.3. Stairs	
4.4. Precast Cladding Panels	
4.5. Post-Construction Alterations	
4.6. Effects of Time	
4.7. Design Standards	
<b>5. Earthquake Effects on Site and Building.....</b>	<b>13</b>
5.1. Response Spectra	
5.2. Liquefaction and Foundation Issues	
5.3. Damage Prior to the February Event	
5.4. Pounding	
<b>6. Failure/Damage Description.....</b>	<b>18</b>
6.1. Shear Wall D5-6	
6.2. Columns B5 and B6 (also C5 & C6)	
6.3. Upper Tower Beams D6-7 and E6-7	
6.4. Lower Tower Beams E6-7	
6.5. Cantilever Transfer Beam 8D-E	
6.6. Precast Panel Connections	
6.7. Level 2 Slab South-East Corner	
6.8. Level 14 Diaphragm Slab	
6.9. Carpark Shear Walls Adjacent to Grid A	
6.10. Stairs	
6.11. Upper Tower Perimeter Seismic Frames	
6.12. Upper Tower Grid E Frame	
6.13. Upper Tower Floors	
6.14. Ground Level Shear Walls	
6.15. West Side Pounding	

<b>7. Failure/Collapse Mechanism.....</b>	<b>22</b>
<b>8. Evaluation and Analysis.....</b>	<b>23</b>
8.1 Shear Wall D5-6 Failure	
8.2 Stair Flights Collapse	
8.3 Carpark Shear walls Adjacent to Grid A	
8.4 Upper Tower Grid E Frame	
<b>9. Conclusions.....</b>	<b>28</b>
<b>10. Discussion.....</b>	<b>29</b>
10.1 Response to 22 February event	
10.2 Did the structure comply with the Codes of the day?	
10.3 Would the failure have occurred in a 'Code' event?	
10.4 Would the building have collapsed in a NZS1170.5 defined event?	
10.5 What was the %NBS on 21 February?	
10.6 Would the stairs have collapsed without the critical wall failure?	
<b>11. Recommendations.....</b>	<b>31</b>
<b>Appendices</b>	
A. List of Reference Material	
B. Selected annotated original documentation	
C. Photographs	
D. Post September Inspection Reports	
E. Concrete test results	
F. Evaluation & Analysis	
G. Geotechnical Information	

Appendix

G

# Forsyth Barr Building consultant report





Investigation into the Collapse of the Forsyth Barr Building Stairs on 22<sup>nd</sup> February 2011

### Table of Contents

<b>Executive Summary</b> .....	<b>1</b>
<b>1 Introduction</b> .....	<b>5</b>
<b>2 Objectives and Scope</b> .....	<b>6</b>
<b>3 Approach / Methodology</b> .....	<b>7</b>
3.1 General.....	7
3.2 Information Gathering.....	8
3.3 Structural Analysis.....	8
3.4 Geotechnical Assessment.....	8
3.5 Reporting.....	8
<b>4 Building Description</b> .....	<b>9</b>
4.1 Outline Description.....	9
4.2 Building History.....	12
4.3 Site Investigations (Soils, Seismology).....	13
4.4 Design, Drawings and Specifications.....	18
4.5 Variations During Construction.....	18
4.6 Post-Occupancy Alterations.....	18
<b>5 Earthquake Effects on Site and Building</b> .....	<b>20</b>
5.1 Earthquake Records.....	20
5.2 4 <sup>th</sup> September 2010 and Aftershock Sequence.....	23
5.3 Boxing Day, 25 <sup>th</sup> December 2010.....	26
<b>6 Effects of 22<sup>nd</sup> February 2011 Event at Forsyth Barr Site</b> .....	<b>29</b>
6.1 Earthquake Records.....	29
6.2 Observed Building/Site Performance.....	31
6.3 Site Performance.....	32
<b>7 Collapse Description</b> .....	<b>33</b>
<b>8 Evaluation/Analysis of the Collapse</b> .....	<b>38</b>
8.1 Structure Condition/Capacity Prior to Collapse.....	38
8.2 Effects of Earthquake on Site and Structure.....	38
8.3 Consultant Evaluation of and Reasons for Collapse.....	40
<b>9 Conclusions</b> .....	<b>43</b>
<b>10 Discussion</b> .....	<b>44</b>
10.1 Discussion of Key Issues as Necessary to Accompany Conclusions.....	44
10.2 Comments on Implications for Future Standards and Practice.....	44
<b>11 Recommendations</b> .....	<b>46</b>
<b>12 References</b> .....	<b>47</b>

Investigation into the Collapse of the Forsyth Barr Building Stairs on 22<sup>nd</sup> February 2011

## Appendices

### A1 Building Data

A1.1 Landmark Tower Robert Jones House Selected Drawings

### A2 Reports on Structure

A2.1 Level 2 Rapid Assessment 5<sup>th</sup> September 2010  
 A2.2 Post Earthquake Assessment and Repair Report 20<sup>th</sup> November 2010  
 A2.3 Level 2 Rapid Assessment April 2011  
 A2.4 31<sup>st</sup> March 2011 Site Report  
 A2.5 Preliminary Structural Review 13<sup>th</sup> April 2011  
 A2.6 Site Visit 14<sup>th</sup> September 2011

### A3 Structural Analyses

A3.1 Introduction  
 A3.2 3D Building Model – Elastic Modal Analyses  
 A3.3 3D Building Model – Elastic Time-History Analyses  
 A3.4 Elastic Stair Unit Analyses  
 A3.5 Section Capacities  
 A3.6 Non-Linear Pushover Stair Unit Analyses  
 A3.7 Knee Joint

### A4 Site Data

A4.1 Geotechnical Report

# Addenda to Forsyth Barr Building Consultant Report

## Addendum (1)

The following statement has been deleted from the second paragraph of section 5.2.2 on page 24 of our (Beca) report dated 26 September 2011:

“The engineers have advised that they were told to exclude the stairs from consideration”.

## Addendum (2)

Since the release of our (Beca) report on 26 September 2011, the following information has come to our attention:

In 2000, a report on the testing of a precast stair unit almost identical to those installed in the Forsyth Barr building was published (Simmons, P.W., *The Safety of Single Storey Straight Stairflights with Mid-height Landings Under Simulated Seismic Displacements*, Research Report 2000-09, Civil Engineering, University of Canterbury, July 2000).

We note the following points in it:

The Abstract includes: “The importance of maintenance of existing seismic gaps cannot be overstressed”

The Introduction states that the purpose of the research was to:

- assess the performance and safety of existing concrete stair designs
- produce an improved detail for maintaining the structural integrity of concrete stairs (if warranted)
- suggest a means of retrofit, etc.

The body of the report includes the following:

- The precast unit that collapsed in Wellington in 1988 had not yet been cast in at its upper end – it might have lost its temporary top seating.
- It was known that refurbishment of stairwells was resulting in grouting of seismic gaps.
- The identification of whether catastrophic failure of the stair’s knee joint could occur was the research thrust
- Permanent shortening of the stair unit (up to 25 mm) after testing was recorded
- In discussions with BRANZ re possible buckling of top steel in the stair, it was “reiterated that safe egress of people on the damaged stair was the major priority”.

The Conclusions included:

1. It is imperative that the design of stair systems in multi-storey buildings ensures the vertical egress route for the building occupants is available in emergency situations.
2. This form of stair is “inherently robust”
3. “the future use of stairs of this configuration can eliminate the possibility of the stair becoming a brace by ensuring the design does not allow the stair to be supported into the side of a floor member. If the stair is supported on the top surface of the lower floor, horizontal loads cannot be transferred through the stair once the frictional resistance is overcome”.

Although this research did not specifically look at the adequacy of seats, it very much supports the findings and recommendations of our (Beca) investigation.

Appendix

H

# Contextual report



## General Building Performance in the Christchurch CBD: a contextual report

*Prepared for the  
Department of Building and Housing (DBH)*

*as part of the Technical Investigations into the Performance of Buildings  
in the Christchurch CBD in the 22 February Christchurch Aftershock*

By:  
Dr. Weng Yuen Kam  
Associate Prof. Stefano Pampanin

November 2011

General Building Performance in the Christchurch CBD: a contextual report – Karen W., Panagiotis S.

\*\*\*

## Table of Content

Table of Content	2
1. Introduction	4
2. Scope and Objectives	4
3. Limitations and Applicability of the Report	5
4. Introduction to the 22 February Earthquake	6
5. Earthquake excitations	7
5.1. 4 September 2010 7.1M <sub>w</sub> main shock and aftershocks	7
5.2. The 22 Feb 2011 Mw 6.2 'aftershock' and its peculiarity	8
5.3. Seismic shaking intensity	10
5.3.1. Seismic shaking intensity as response spectra	10
5.3.2. Seismic instrumentation within the Christchurch CBD	11
5.3.3. 4 Sept 2010 earthquake response spectra	11
5.3.4. 26 Dec 2010 earthquake response spectra	17
5.3.5. 22 Feb 2011 earthquake response spectra	18
5.4. Vertical acceleration	22
5.5. Duration of shaking and proximity to the source	23
5.6. Liquefaction and lateral spreading	24
5.7. Foundation damage to buildings	26
5.8. Final remarks on shaking intensity of 4 Sept 2010 and 22 February 2011	27
6. Background of New Zealand seismic design codes	30
6.1. Evolution of building codes up to early seismic codes (1960s)	30

Table of Content - 2

General Building Performance in the Christchurch CBD: a contextual report – Sam W., Pampanin S.

\*\*\*

6.2. Development of building codes for seismic resistance (1960-70s).....	32
6.3. Development of 'modern' seismic codes (1976 onwards).....	33
6.4. Performance based design: expected level of damage vs. seismic intensity.....	34
7. Building inventory in the CBD and observed damage: an Overview.....	36
8. Unreinforced Masonry (URM) buildings.....	40
9. Reinforced Concrete Masonry (RCM) buildings.....	41
10. Reinforced Concrete Frame buildings.....	42
11. Reinforced Concrete/ Steel Frames with Infills buildings.....	44
12. Reinforced Concrete Wall buildings.....	45
13. Tilt-up Concrete Panel buildings.....	47
14. Steel frame and steel braced buildings.....	48
15. Timber frame buildings.....	50
16. Specific Issues.....	51
16.1. Staircase performance in multi-storey buildings.....	51
16.2. Non-structural damage and facade.....	54
16.3. Displacement-incompatibility (Floors and gravity elements).....	55
Appendix A: Christchurch CBD Building Stock Data.....	57
Appendix B: References.....	58
Appendix C: Terms of Reference from DBH (version 28 April 2011).....	61

Table of Content • 3



